

*Linea de Motor*

**LESSIA**<sup>®</sup>  
Motorcycle Products

# MOTOR LINE

*Linea de Motor*



**MOTOR LINE**

**LESSIA**<sup>®</sup>  
Motorcycle Products

#SomosPartedeTuMoto

*#SomosPartedeTuMoto*

Linea de Motor

MOTOR LINE

LESSIA  
Motorcycle Products

#SomosPartedeTuMoto

LESSIA  
Motorcycle Products



### ANI-010-IR

ANILLOS STD-(Iron Box)

IT 125-FL 19-20 /IT 125-FL  
PARRILLA LARGA 19-20



### ANI-005-F

ANILLOS STD-(kiirus)

IT 125-Z 16-17



### ANI-DM-STD-IR

ANILLOS STD-(Iron Box)

IT 150-SZ 16-18 /IT 150-Z 14-  
16 /IT 170-Z 16-18/IT DM-150  
10-19/IT DM-150 ROJA 18-19/  
IT DT-150 CLASICA 17-18



### ANI-DM-STD-F

ANILLOS KIIRUS STD-  
(kiirus)

IT 150-SZ 16-18 /IT 150-Z 14-  
16 /IT 170-Z 16-18/IT DM-150  
10-19/IT DM-150 ROJA 18-19/  
IT DT-150 CLASICA 17-18



### ANI-004-F

ANILLOS KIIRUS STD-  
(kiirus)

IT 250-Z 14-17 / IT 250-Z  
NEGRA 17 / IT DM-250 16 /IT  
RT-250 16-17



### ANI-004-IR

ANILLOS STD-(Iron Box)

IT 250-Z 14-20 /IT 250-Z  
NEGRA 17-19 / IT DM-250  
16-18 /IT RT-250 16-20

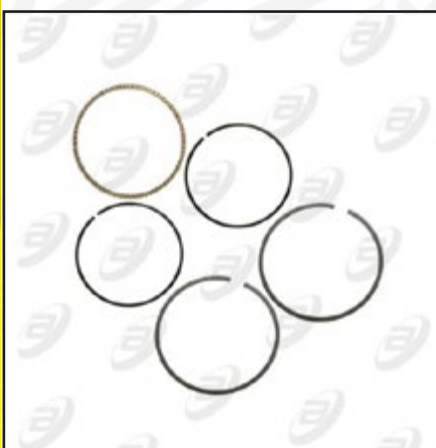

### ANI-GYF-STD-IR

ANILLOS STD-(Iron Box)

IT AR-110 15 /IT AT-110 14-16  
/IT AT-110 NEGRA 16-17 /  
IT AT-110 RT 12-14 /IT AT-  
110RTLED 14-16 /IT AT-110RT  
16-19



### ANI-GYF-STD-F

ANILLOS KIIRUS STD-  
(kiirus)

IT AR-110 15/IT AT-110 14-16/  
IT AT-110 NEGRA 16-17/IT AT-  
110 RT 12-14/IT AT-110RTLED  
14-16/IT AT-110RT CON LED  
16-19



Linea de Motor

MOTOR LINE

LESSIA  
Motorcycle Products

#SomosPartedeTuMoto

LESSIA  
Motorcycle Products



### ANI-009-IR

ANILLOS STD-(Iron Box)

IT AT-125 17-19



### ANI-GYG-STD-F

ANILLOS KIIRUS STD-  
(kiirus)

IT ATV-150 05 / IT DS-150 14-  
20 / IT DS-150 NEGRO 13-15 /  
IT DIABOLO-150 06-16 / IT  
D-150 19 / IT DS-150 G 18-19



### ANI-GYG-STD-IR

ANILLOS STD-(Iron Box)

IT ATV-150 05 / IT DS-150 14-  
17 / IT DS-150 NEGRO 13-15 /  
IT DIABOLO-150 06-13 / IT  
GS-150 10-13 / IT GS-150 CON  
LEDS

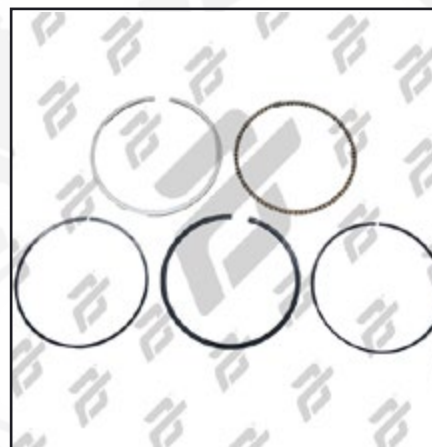

### ANI-021-IR

ANILLOS STD IRON-(Iron  
Box)

IT ATV-200 20-23

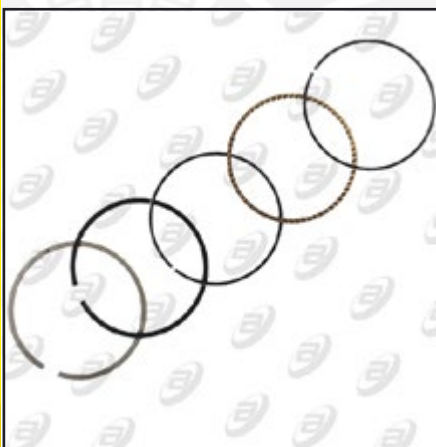

### ANI-006-IR

ANILLOS STD-(Iron Box)

IT DM-125 17-19

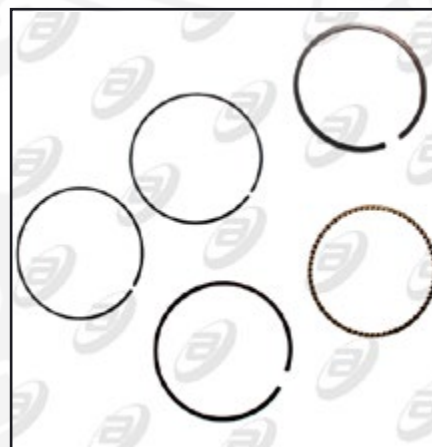

### ANI-012-IR

ANILLOS STD-(Iron Box)

IT DM-150 SPORT 19-20



### ANI-FT150-0.50-IR

ANILLOS 050

DM-150 / FT-150GT / FT-150  
09-11 / KURAZAI DELIVERY



### ANI-001-F

ANILLOS KIIRUS STD-  
(kiirus)

IT DM-200 14-19 / IT DM-200  
SPORT 19 / IT DT-200 SPORT  
17-19 / IT FIERA-200 18-19 /  
IT FT-200 14-15 / IT FT-200  
AMA

Linea de Motor

MOTOR LINE

LESSIA  
Motorcycle Products

#SomosPartedeTuMoto

LESSIA  
Motorcycle Products



### ANI-CGF-STD-IR

#### ANILLOS STD-(Iron Box)

IT DT-125 12-16 /IT DT-125  
CLASICA 17 /IT DT-125  
DELIVERY 17 /IT DT-125  
SPORT 17 /IT FORZA 125 05-  
12 /IT FT-125



### ANI-CGF-STD-F

#### ANILLOS KIIRUS STD- (kiirus)

IT DT-125 12-16 /IT DT-125  
CLASICA 17 /IT DT-125  
DELIVERY 17 /IT DT-125  
SPORT 17 /IT FORZA 125 05-  
12 /IT FT-125



### ANI-CGG-STD-F

#### ANILLOS KIIRUS STD- (kiirus)

IT DT-150 BASIC 18-19 /  
IT DT-150 CLASICA 19 /IT  
DT-150 DELIVERY 19 /IT  
FORZA-150 07-08 /IT FT-150  
GRAFITO 18-19

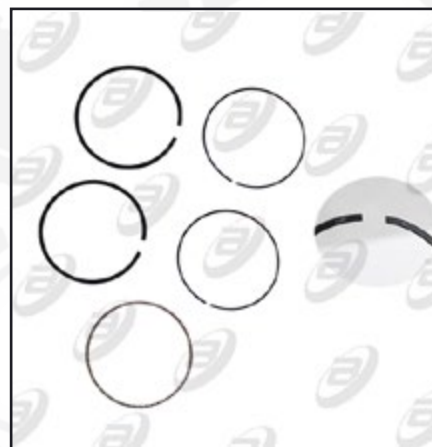

### ANI-010F

#### ANILLOS KIIRUS 0.25-(kiirus)

IT DT-150BA /IT DT-150CL /  
IT DT-150DE /IT FORZA-150  
/IT RC-150 /IT RC-150GT /  
IT FT-150GR /IT FT-150TS /IT  
FT-180



### ANI-EX-STD-F

#### ANILLOS KIIRUS STD- (kiirus)

IT EX-200 07-08 /IT RT-200  
09-16 /IT RT-200 GP 17-19 /  
IT RT-200 20 /IT RT-200  
NEGRO 13-15



### ANI-FT250-F

#### ANILLOS KIIRUS STD- (kiirus)

IT FT-250 /IT TC-250 /IT  
250-SZ



### ANI-FT250-IR

#### ANILLOS STD-(Iron Box)

IT FT-250 /IT TC-250 /IT 250-  
SZ



### ANI-GTS-STD-F

#### ANILLOS KIIRUS STD- (kiirus)

IT GSC-175 15-18 /IT GTS-175  
10-14 /IT GTS-175 CON LEDS  
13-15 /IT GTS-175 LED CAJA  
14-15 /IT MODENA-175 18-  
22 /IT TRN-175 16 /IT TS-170  
09 /IT WS-175 12-18 /IT WS-  
175 SP 18-22



Linea de Motor

MOTOR LINE

LESSIA  
Motorcycle Products

#SomosPartedeTuMoto

LESSIA  
Motorcycle Products



### ANI-GTS-STD-IR

#### ANILLOS STD-(Iron Box)

IT GSC-175 15-18 /IT GTS-175 10-14 /IT GTS-175 CON LEDS 13-15 /IT GTS-175 LED CAJA 14-15 /IT MODENA-175 18-22 /IT TRN-175 16 /IT TS-170 09 /IT WS-175 12-18 /IT WS-175 SP 18-22



### ANI-011-IR

#### ANILLOS STD-(Iron Box)

IT RC-200 19-20 / IT SPITFIRE 19



### ANI-ST-STD-IR

#### ANILLOS STD-(Iron Box)

IT ST-70 05-08 /IT ST-90 09-18 /IT DT-90 17 /IT T-REX-70 14-15



### ANI-ST-STD-F

#### ANILLOS KIIRUS STD-(kiirus)

IT ST-70 05-08 /IT ST-90 09-21 /IT DT-90 17 /IT T REX-70 14-15



### ANI-018-IR

#### ANILLOS STD-(classic)

IT V-200 18-22

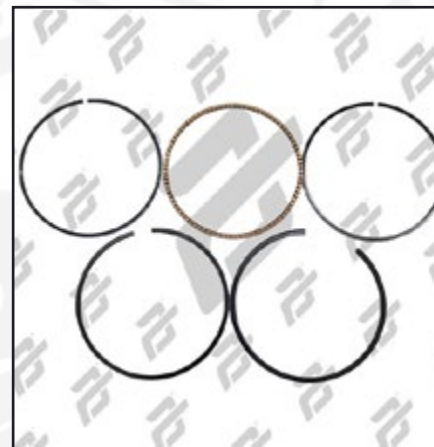

### ANI-022-IR

#### ANILLOS STD

SK GIXXER-150 21-23



### ANI-023-IR

#### ANILLOS STD

VN NITROX-300 T3 23-24

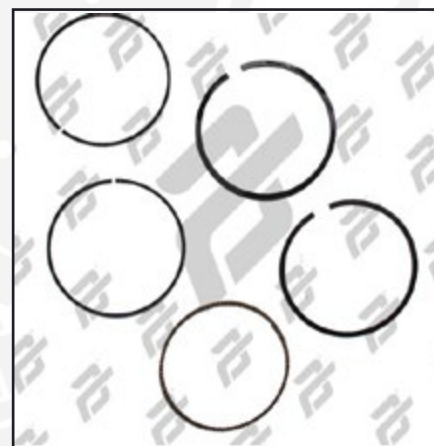

### ANI-019-IR

#### ANILLOS STD-(Iron Box)

VN NITROX-250T2 21-22 /VN NITROX-250T3 22-24

Linea de Motor

MOTOR LINE

LESSIA  
Motorcycle Products

#SomosPartedeTuMoto

LESSIA  
Motorcycle Products



### ANI-020-IR

ANILLOS STD-(Iron Box)

VN ROCKETMAN-250 19-22/VN ROCKETMAN-250SP 21-22/VN ROCKETMAN-250CA 21-22/VN CROSSMAX-250 19-22/VN CROSSMAX PRO-250 21-22/VN SCREAMER-250 21-22/VN FALKON-250 21-22/VN STORM-250 21-22/VN TORNADO-250 21-22/VN



### ANI-FZ16-STD-IR

ANILLOS STD-(Iron Box)

YA FZ-16 12-13



### ANI-003-F

ANILLOS KIIRUS STD-(kiirus)

YA YBR-125

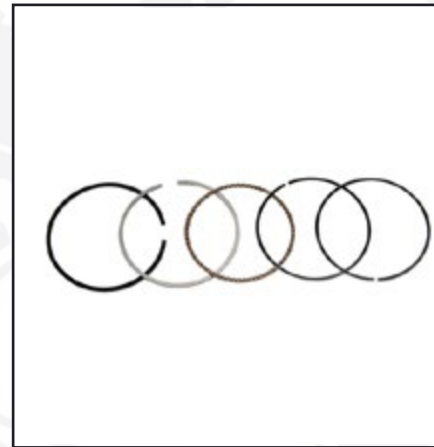

### ANI-007

ANILLOS STD-(Rudos Biker)

YA YBR-125



### ARB-014

ARBOL DE LEVAS-(Rudos Biker)

BJ BOXER-150



### ARB-002

ARBOL DE LEVAS-(classic)

HO CARGO-125/ CGL-125  
TOOL 10-12



### ARB-008

ARBOL DE LEVAS-(Rudos Biker)

HO CARGO-150 GL



### ARB-006

ARBOL DE LEVAS-(classic)

HO CARGO-150 GL



Linea de Motor

MOTOR LINE

LESSIA  
Motorcycle Products

#SomosPartedeTuMoto

LESSIA  
Motorcycle Products



### ARB-009

ARBOL DE LEVAS-(Rudos Biker)

HO CGL-125 TOOL



### ARB-015

ARBOL DE LEVAS-(classic)

IT 125-FL 19-20/IT 125-FL  
PARRILLA LARGA 19-20



### ARB-CGM-01

ARBOL DE LEVAS-(classic)

IT 125-Z 17-20/IT 150-  
SZ 16-18/IT 150-Z 14-20/  
IT FORZA-125 05-16/IT  
FORZA-150 06-13/IT DM-  
125 17-19/IT DM-150 10-19/IT  
DM-150 RO 18-19 /IT DM-150  
SP 19-20/IT DM-200 14-20/  
IT DT-125 12-16/IT DT-125 CL  
17-19/IT DT-125 DE 17-19/IT  
DT-125 SP 17-19/IT DT-125 SP



### ARB-007

ARBOL DE LEVAS-(classic)

IT 250-Z 14-17 /IT 250-Z  
NEGRA 17-19



### ARB-SAE-01

ARBOL DE LEVAS-(classic)

IT AR-110 15 /IT AT-110 14-16  
/IT AT-110 NEGRA 16-18 /IT  
AT-110 SPORT 11-15 /IT AX-110  
16 /IT ARGENTA 110 05-13 /IT  
XT-110 GRAFITO 17 /IT XT-110  
RT 17



### ARB-004

ARBOL DE LEVAS-(classic)

IT AT-110 ROJA 17-19 /IT AT-  
110 RT 12-14 /IT AT-110RT LED  
14-16 /IT AT-110 RT CON LED  
16-19 /IT X-110 17-19



### ARB-017

ARBOL DE LEVAS-(classic)

IT ATV-180 16-23/VN  
TERRA-150 20-23/VN  
HOT ROD-150 20-23/VN  
STREETROD-150 20-23



### ARB-016

ARBOL DE LEVAS-(classic)

IT ATV-250 C/REVERSA 14-  
18 /IT ATV-250 NE 18-20





**ARB-GYM-02**

ARBOL DE LEVAS-(classic)

IT CS-125 14-18 /IT CS-125 LED 13-16 /IT D-125 16-20 /IT DS-125 17-20 /IT D-150 19 /IT DS-150 14-20 /IT DS-150G 18-19 /IT DS-150 VERDE 18-19 /IT DS-150 NEGRO 13-15 /IT CITY-125 05-13 /IT DS-125 05-09 /IT DS-150 05-16 /IT GS-150 10-13 /IT GS-150 CON LED 14-15 /IT GS-150 LED



**ARB-001**

ARBOL DE LEVAS-(classic)

IT ST-70 05-08 /IT ST-90 09-18 /IT DT-90 17 /IT T-REX-70 14-15



**ARB-018**

ARBOL DE LEVAS-(classic)

IT V-200 18-20



**ARB-019**

ARBOL DE LEVAS-(classic)

IT VORTX-200 18-21



**ARB-021**

ARBOL DE LEVAS-(classic)

VN ROCKETMAN-250 19-22 /VN ROCKETMAN-250SP 21-22 /VN ROCKETMAN-250CR 21-22 /VN CROSSMAX-250 19-22 /VN CROSSMAX-250PRO 21-22 /VN SCREAMER-250 22 /VN FALKON-250 21-22 /VN STORM 250 21-22 /VN TORNADO-250 21-22 /VN



**ARB-005**

ARBOL DE LEVAS-(classic)

YA YBR-125



**BLC-027**

BALANCIN

BJ PULSAR NS-150



**BLC-014**

BALANCIN-(Rudos Biker)

BJ BOXER-150



Linea de Motor

MOTOR LINE

LESSIA  
Motorcycle Products

#SomosPartedeTuMoto

LESSIA  
Motorcycle Products



### BLC-015

BALANCIN-(Rudos Biker)

BJ NS-200



### BLC-007

BALANCIN-(Rudos Biker)

HO CARGO-150



### BLC-013

BALANCIN SUPERIOR C/  
SOPORTE-(Rudos Biker)

HO CARGO-150



### BLC-008

BALANCIN-(Rudos Biker)

HO CGL-125 TOOL



### BLC-022

BALANCIN SUPERIOR-  
(classic)

IT 125-FL-19-20 /IT 125-FL  
PARRILLA LARGA 19-20



### BLC-021

BALANCIN INFERIOR-  
(classic)

IT 125-Z 16-20 / IT 150SZ 16-  
18 /IT 150-Z 14-20 /IT DM-150  
ROJA 18-20 /IT DT-150 CL  
17-18 /IT DT-150DEL 17-18



### BLC-006

BALANCIN SUPERIOR C/  
SOPORTE-(classic)

IT 125-Z 16-20 /IT 150-Z 14-20  
/IT 150-SZ 16-18 /IT DM-  
150 ROJA 18-19 /IT DT-150  
CLASICA 17-18 /IT DT-150  
DELIVERY 17-18 /IT FT-150  
DELIVERY 17-18 /IT FT-150 S  
15-18 /IT RC-150 16-20



### BLC-CGM-02

BALANCIN INFERIOR C/  
EJE-(classic)

IT 125-Z 19 /IT DM-150 10-19 /  
IT DT-125 CLASICA 17-19 /IT  
DT-125 DELIVERY 17-20 /IT  
DT-125 SPORT 17-20 /IT DT-  
150 BASIC 18-20 /IT DT-150  
CLASICA 19-20 /IT DT-150  
SPORT 17-18 /IT FORZA-125  
05-12 /IT FORZA-150 06-13 /  
IT EX-200 05-08 /IT FT-125



Linea de Motor

MOTOR LINE

LESSIA  
Motorcycle Products

#SomosPartedeTuMoto

LESSIA  
Motorcycle Products



### BLC-CGM-01

#### BALANCIN SUPERIOR C/ SOPORTE-(classic)

IT 125-Z 19 /IT DM-150 10-19 /  
IT DT-125 CLASICA 17-19 /IT  
DT-125 DELIVERY 17-20 /IT  
DT-125 SPORT 17-20 /IT DT-  
150 BASIC 18-20 /IT DT-150  
CLASICA 19-20 /IT DT-150  
SPORT 17-18 /IT FORZA-125  
05-12 /IT FORZA-150 06-13 /  
IT EX200 05-08 /IT FT-125



### BLC-011

#### BALANCIN-(classic)

IT 170-Z 16-17 /IT 200-Z 19 /  
IT DM-250 16-18 /IT RT-250  
16-20



### BLC-020

#### BALANCIN SUPERIOR- (classic)

IT 250-SZ 15 / IT DT-250SP  
20 /IT FIERA 250 18-19 /  
IT FT-250 15-20 /IT TC-250  
15-20



### BLC-005

#### BALANCIN SUPERIOR C/ SOPORTE-(classic)

IT 250-Z 14-17 / IT 250-Z  
NEGRA 17-19



### BLC-002

#### BALANCIN SUPERIOR C/ SOPORTE-(classic)

IT AT-125 17-19 /IT AT-110  
14-16 /IT AR-110 15 /IT AT-  
110 NEGRA 16-18 /IT AT-110  
ROJA 17-19 /IT AT-110 RT  
LED 14-16 /IT AT-110 RT CON  
LED 16-19 /IT XT- 110 11-15 /  
IT AT- 110 SPORT 11-15 /IT  
AT-110 RT 12-14 /IT AX-110  
16 / IT ARGENTA-110 05-13



### BLC-023

#### BALANCIN SUPERIOR- (classic)

IT ATV-150 C/REVERSA  
19-20 /IT CS-125 14-18 / IT  
D-125 16-20 / IT D-150 19-20  
/ IT DS-125 17-20 /IT DS-150  
14-20



### BLC-017

#### BALANCIN SUPERIOR C/ SOPORTE-(classic)

IT ATV-180 16-20



### BLC-019

#### BALANCIN SUPERIOR- (classic)

IT ATV-250 C/REVERSA 14-  
18 / IT ATV-250 NE 18-20



Linea de Motor

MOTOR LINE

LESSIA  
Motorcycle Products

#SomosPartedeTuMoto

LESSIA  
Motorcycle Products



### BLC-GYM-01

#### BALANCIN SUPERIOR C/ SOPORTE-(classic)

IT CS-125 14-18 /IT CS-125  
LED 13-16 /IT D-125 16-20 /  
IT DS-125 05-20 /IT DS-150  
05-20 /IT DS-150 G 18-19 /IT  
DS-150 VERDE 18-19 /IT DS-  
150 NEGRO 13-15 /IT CITY-  
125 05-13 /IT VENDETTA-90  
06-08 /IT GS-150 10-13 /IT  
GS-150 CON LED 13-15 /IT



### BLC-004

#### BALANCIN SUPERIOR C/ SOPORTE-(classic)

VN RYDER 5.0-190 23-24 /  
IT DM-200 14-24 / IT DM-  
200SP 19-21 / IT DM-250 20-  
24 / IT DM-250X 22-24 / IT  
DM-125 17-21 / IT DM-150SP  
19-21 / IT FT-180TS 19-23 / IT  
RC-200 19-24 / IT SPTFIRE  
19-22 / IT FT-200TS 19-24 / IT  
RT-200 09-24 / KE TX-200



### BLC-018

#### BALANCIN INFERIOR- (classic)

IT DM-200 14-20 /IT DM-  
200SP 19-20 /IT DM-250 20



### BLC-025

#### BALANCIN-(classic)

IT V-200 18-20



### BLC-024

#### BALANCIN-(classic)

IT VORTX-200 18-20



### PSK-015

#### PORTA SPROKET-(classic)

VN ROCKETMAN-250 19-  
22/VN ROCKETMAN-250SP  
21-22/VN ROCKETMAN-  
250CA 21-22/VN  
CROSSMAX-250 19-22/VN  
CROSSMAX-250PRO 21-22/  
VN SCREAMER-250 21-22/  
VN FALKON-250 21-22/  
VN STORM-250 21-22/VN  
TORNADO-250 21-22/VN



### PSK-017

#### PORTA SPROKET

VN NITROX-200 19-24 / VN  
NITROX-250T2 19-24 / VN  
NITROX-250T3 22-24 / VN  
NITROX-300T3 23-24



### BLC-026

#### BALANCIN-(classic)

VN TERRA-150/VN HOT  
ROD-150





**BLC-CGM-02**

BALANCIN INFERIOR C/  
EJE-(classic)

VN TERRA-150/VN HOT  
ROD-150



**BLC-009**

BALANCIN-(Rudos Biker)

YA YBR-125



**BLC-A005**

KIT DE BALANCIN-(classic)

HO CARGO-150



**BLC-A001**

KIT DE BALANCIN-(Iron  
Box)

IT 125-Z 16-20 /IT 150SZ 16-  
18 /IT 150-Z 14-16 /IT 150-Z  
19-20 /IT DM-150RO 18-19 /  
IT DT-150CL 17-18 /IT DT-150  
DELIVERY



**BLC-A004**

KIT DE BALANCIN-(Iron  
Box)

IT 125-Z 19 / IT DM-150 10-19  
/IT DT-125CL 17-19 /IT DT-  
125DEL 17-20 /IT DT-125SP  
17-19 /IT DT-150BA 18-20 /IT  
DT-150 CL 19-20



**BLC-A003**

KIT DE BALANCIN-(Iron  
Box)

IT DM-200 14-20/IT DM-  
200SP 19-20/IT DT-200SP  
17-18/IT FIERA-200 18/IT  
FT-200 14-15/IT FT-200AM  
15-17/IT TC-200 14-16



**BLC-A006**

KIT DE BALANCIN-(classic)

YA YBR-150



**BAN-GYF-01**

BANDA DE TRANSMISION  
743-20-30-(Gold)

IT ATV-150 06-11 /IT ATV-150  
SPORT 11-12 / IT ATV-150  
SPORT C / REVERSA 12-17 /  
IT CS-125 14-17 / IT CS-125  
LED 13 / VN OVNI-170 24



Linea de Motor

MOTOR LINE

LESSIA  
Motorcycle Products

#SomosPartedeTuMoto

LESSIA  
Motorcycle Products



### BAN-002

BANDA DE TRANSMISION  
835-20-30-(Gold)

IT DS-150 14-17 /IT DS-150  
NEGRO 13-15 /IT DIABOLO  
125 05-09 /IT DIABOLO-150  
06-13 /IT GS-150 10-13 /IT  
GS-150 C



### BAN-GYG-01

BANDA DE TRANSMISION  
842-20-30-(Gold)

IT DS-150 14-17 /IT DS-150  
NEGRO 13-15 /IT DIABOLO  
125 05-09 /IT DIABOLO-150  
06-13 /IT GS-150 10-13 /IT  
GS-150 C



### BAN-GYG-01F

BANDA DE TRANSMISION  
842-20-30 KIIRUS-(kiirus)

IT DS-150 14-18 /IT DS-  
150 VERDE 18 /IT DS-150  
NEGRO 13-15 /IT DS 125  
05-09 /IT DS-150 06-13 /IT  
GS-150 CON LED



### BAN-002F

BANDA DE TRANSMISION  
835-20-30 KIIRUS -(kiirus)

IT DS-150 14-18 /IT DS-  
150 VERDE 18 /IT DS-150  
NEGRO 13-15 /IT DS 125  
05-09 /IT DS-150 06-13 /IT  
GS-150 CON LED



### BAN-004

BANDA DE TRANSMISION  
730-18.5-28

HO DIO-110



### BAN-004F

BANDA DE TRANSMISION  
730-18.5-28

HO DIO-110



### BAN-GYF-01F

BANDA DE TRANSMISION  
743-20-30 KIIRUS -(kiirus)

VN OVNI-170 24 /IT ATV-150  
06-11 /IT ATV-150 SPORT  
11-12 /ITATV-150 SPORT C  
/ REVERSA 12-17 /IT CS-125  
14-17 /IT CS-125 LED 13



### BAN-005

BANDA DE TRANSMISION  
745-19.5

YA NAVI-110



**COP-A001**

BAQUELITA DE COPLE DE  
CARBURADOR-(classic)

IT AT-110 / KU GALAXY-125  
05-13



**COP-A002**

BAQUELITA DE COPLE DE  
CARBURADOR-(classic)

IT FT-180 13-17 /IT RT-180  
11-13



**BOM-008**

BOMBA DE ACEITE  
COMPLETA-(Rudos Biker)

BJ BOXER-150



**BOM-011**

BOMBA DE ACEITE-  
(Rudos Biker)

BJ NS-200



**BOM-009**

BOMBA DE ACEITE  
COMPLETA-(Rudos Biker)

HO CARGO-150 GL



**BOM-003**

BOMBA DE ACEITE  
COMPLETA-(Rudos Biker)

HO CGL-125 TOOL



**BOM-004**

BOMBA DE ACEITE  
COMPLETA-(classic)

IT 125-Z 16-20 /IT 150-SZ  
16-18 /IT 150-Z 14-20 /IT DM-  
150 ROJA 18-20 /IT DT-150  
CLASICA 17-19 /IT DT-150  
DELIVERY 17-18 /IT FT-150  
DELIVERY 15-18 /IT FT-150 S  
15-18 /IT FT-150 TS 16-18 /IT  
RC 150 16-20 /IT RC-125 20



**BOM-015**

BOMBA DE ACEITE  
COMPLETA-(classic)

IT 170-Z 16-18/IT 200-Z  
19-20/IT DM-250 16-18/IT EX-  
200 05-06





**BOM-001**

**BOMBA DE ACEITE  
COMPLETA-(classic)**

IT 250-Z 14-17 / IT 250-Z  
NEGRA 17-19 / IT FORZA-150  
07-08 / IT EX-200 07-08 / IT  
RC-150 09-17 / IT RC-150 GT  
12-15 / IT RC-200 19-20 / IT  
RT-200 09-20 / IT RT-200 GP  
17-19 / IT SPTFIRE-200 19



**BOM-013**

**BOMBA DE ACEITE  
COMPLETA-(classic)**

IT 250-Z 19-20 / IT RT-250  
16-20



**BOM-SAE-01**

**BOMBA DE ACEITE  
COMPLETA-(classic)**

IT AT-110 14-16 / IT AT-110  
ROJA 17-19 / IT AT-110 RT 12-  
14 / IT AT-110 RT LED 14-16 / IT  
AT-110 RT CON LED 16-20 / IT  
AT-110 SPORT 11-15 / IT DT-90  
17 / IT ARGENTA-110 05-13 / IT  
STRADA-70 05-08 / IT FT-110  
10-16 / IT X-110 17-19 / IT XT-110  
11-15 / IT XT-110 GRAFITO 13-



**BOM-017**

**BOMBA DE ACEITE  
COMPLETA-(classic)**

IT AT-125 17-20 / IT AT-125RT  
20



**BOM-016**

**BOMBA DE ACEITE  
COMPLETA-(classic)**

IT ATV-150SP 11-12 / IT  
ATV-150 REVERSA 19-20 /  
IT ATV-150SP REVERSA  
12-19 / IT ATV-180 16-20 / IT  
VITALIA-150 16-21



**BOM-018**

**BOMBA DE ACEITE  
COMPLETA-(classic)**

IT ATV-200 20-24



**BOM-014**

**BOMBA DE ACEITE  
COMPLETA-(classic)**

IT ATV-250 REVERSA 14-18 /  
IT ATV-250NE 18-20



**BOM-GY-01**

**BOMBA DE ACEITE  
COMPLETA-(classic)**

IT CS-125 14-18 / IT CS-125  
LED 13-16 / IT D-125 16-20 /  
IT DS-125 17-20 / IT DS-150  
14-20 / IT DS-150 G 15-20 / IT  
DS-150 VERDE 18-19 / IT DS-  
150 NEGRO 13-15 / IT CITY-  
125 08-13 / IT DIABOLO-125  
05-09 / IT DIABOLO-150  
06-16 / IT GS-150 10-13 /





**BOM-006**

**BOMBA DE ACEITE  
COMPLETA-(classic)**

IT DM-200 14-20 /IT DM-  
200 SPORT 19-20



**BOM-CGM-01**

**BOMBA DE ACEITE  
COMPLETA-(classic)**

IT DT-125 12-16 /IT DT-125  
CLASICA 17 /IT DT-125  
DELIVERY 17 /IT DT-125  
SPORT 17 /IT FORZA 125 05-  
12 /IT FT-125 CLASICA 12-16 /  
IT FT-125 DELIVERY 14-16 /  
IT FT-125 PLATA 17 /IT FT-125  
ROJA 13-18 /IT FT-125 SPORT  
12-15 /IT XFT-125 12-13/VN



**BOM-012**

**BOMBA DE ACEITE  
COMPLETA-(Rudos Biker)**

IT WS-175 12-18/IT WS-175SP  
18-20/IT GSC-175 15-18/  
IT GTS-175 10-14/IT GTS-  
175LED 13-15/IT GTS-175LED  
CAJA 14-15/IT MODENA-175  
18-21



**BOM-019**

**BOMBA DE ACEITE  
COMPLETA (ALESSIA)**

IT VORT-X300 17-24/IT  
VORT-X300R 21-24



**BUJ-ILKAR8**

**BUJIA RUDOS BIKER  
IRIDIC IR-ILKAR8A-9-  
(Rudos Biker)**

BJ PULSAR NS-200



**BUJ-ALE-02**

**BUJIA ALESSIA A-C7HSA  
MOTONETAS UNIVERSAL-  
(classic)**

MOTONETAS



**BUJ-C7HSA**

**BUJIA RUDOS BIKER  
A-C7HSA-(Rudos Biker)**

MOTONETAS



**BUJ-CR7HSA**

**BUJIA RUDOS BIKER  
A-CR7HSA-(classic)**

MOTONETAS



Linea de Motor

MOTOR LINE

LESSIA  
Motorcycle Products

#SomosPartedeTuMoto

LESSIA  
Motorcycle Products



### BUJ-ILKR7

BUJIA RUDOS BIKER  
IRIDIC IR-ILKR7B8-  
(classic)

MOTONETAS



### BUJ-CR8

BUJIA RUDOS BIKER  
A-CR8-(Rudos Biker)

MOTOS D ETRABAJO



### BUJ-ALE-01

BUJIA ALESSIA A-D8EA  
MOTOS DE TRABAJO  
UNIVERSAL-(classic)

MOTOS DE TRABAJO



### BUJ-D8EA

BUJIA RUDOS BIKER  
A-D8EA-(Rudos Biker)

MOTOS DE TRABAJO



### BUJ-DR8EA

BUJIA RUDOS BIKER  
A-DR8EA-(classic)

MOTOS DE TRABAJO



### BUJ-C8

BUJIA RUDOS BIKER  
A-C8-(Rudos Biker)

MOTOS DE TRABAJO



### BUJ-C9

BUJIA RUDOS BIKER  
A-C9-(Rudos Biker)

MOTOS DEPORTIVAS



### BUJ-CR9

BUJIA RUDOS BIKER  
A-CR9-(Rudos Biker)

MOTOS DEPORTIVAS



**CAP-001**

**CAPUCHON DE BUJIA-  
(classic)**

IT 250-Z 14-17 /IT 250-Z  
NEGRA 17 /IT AR-110 15 /IT  
DT-150 SPORT 17 /IT DT-90  
17 /IT FORZA 150 06-13 /IT  
EX 200 07-08



**CAP-002**

**CAPUCHON DE BUJIA-  
(classic)**

IT CS-125 14-18 /IT CS-125  
LED 13-16 /IT D-125 16-20 /IT  
DS-125 17-20 /IT D-150 19-20  
/IT DS-150 14-20 /IT ATV-150  
SPORT 06-11 /IT ATV-150  
SPORT 11-12 /IT ATV-150  
SPORT C/REVERSA 12-19 /  
IT ATV-180 16-20 /IT RT-250  
16-20 /IT MODENA-150 18-



**CAP-004**

**CAPUCHON DE BUJIA-  
(classic)**

IT CS-125 14-18 /IT CS-125  
LED 13-16 /IT D-125 16-20 /IT  
DS-125 17-20 /IT D-150 19-20  
/IT DS-150 14-20 /IT ATV-150  
SPORT 06-11 /IT ATV-150  
SPORT 11-12 /IT ATV-150  
SPORT C/REVERSA 12-19 /  
IT ATV-180 16-20 /IT RT-250  
16-20 /IT MODENA-150 18-



**CAP-005A**

**CAPUCHON CABLE DE  
BUJIA-(classic)**

RACING AMARILLO 556  
mm



**CAB-025**

**CABEZA DE CILINDRO  
COMPLETA PLATA-(Rudos  
Biker)**

HO CARGO-150



**CAB-035**

**CABEZA DE CILINDRO  
COMPLETA-(classic)**

IT 125-FL 19-20 /IT 125-FL  
PAR 19-20



**CAB-CGG-03**

**CABEZA DE CILINDRO  
COMPLETA NEGRO-  
(classic)**

IT 125-Z 16-18



**CAB-019**

**CABEZA DE CILINDRO  
COMPLETA NEGRO-  
(classic)**

IT 150-Z 16-18 /IT 150-SZ  
14-16



Linea de Motor

MOTOR LINE

LESSIA  
Motorcycle Products

#SomosPartedeTuMoto

LESSIA  
Motorcycle Products



### CAB-027

CABEZA DE CILINDRO  
COMPLETA NEGRO-  
(classic)

IT 250-SZ 15 /IT FT-250 15-16  
/IT FT-250 TS 16-19



### CAB-024

CABEZA DE CILINDRO  
COMPLETA NEGRO-  
(classic)

IT 250-Z 14-17 /IT 250-Z  
NEGRA 17-18



### CAB-008

CABEZA DE CILINDRO  
COMPLETA-(classic)

IT AT-110 20/IT AT-110RT C/  
LED 16-20/IT AT-110RT LED  
14-16/IT AT-110RT 12-14 / IT  
AT110RO 17-20/IT X-110 17-19/  
IT XT-110



### CAB-014

CABEZA DE CILINDRO  
COMPLETA PLATA-  
(classic)

IT AT-110 NEGRA 16-17 /IT  
XT-110 GRAFITO 17



### CAB-034

CABEZA DE CILINDRO  
COMPLETA-(classic)

IT AT-125 17-20 /IT AT-125RT  
20



### CAB-GYG-03

CABEZA DE CILINDRO  
COMPLETA PLATA-  
(classic)

IT ATV-150 05/IT DS-150  
14-20/IT DS-150G 18-20/IT  
DS-150VE 18-19/IT DS-150  
NE 13-15/IT DS-150 06-16/  
IT D-150 19-20/IT GS-150  
10-13/IT GS-150 CON LEDS  
13-15/IT GS-150 LED CAJA  
14-15/IT GS-150 LED ELITE



### CAB-036

CABEZA DE CILINDRO  
COMPLETA CON TAPA-  
(classic)

IT ATV-180 16-20



### CAB-GYG-02

CABEZA DE CILINDRO  
COMPLETA PLATA-  
(classic)

IT CS-125 14-18/IT CS-125  
LED 13-16/IT D-125 16-19/  
IT DS-125 17-18/IT DSG-125  
17-19/IT CITY-125 05-13/IT DS-  
125 05-09



Linea de Motor

MOTOR LINE

LESSIA  
Motorcycle Products

#SomosPartedeTuMoto

LESSIA  
Motorcycle Products



### CAB-032

CABEZA DE CILINDRO  
COMPLETA-(classic)

IT DM-125 17-20



### CAB-022

CABEZA DE CILINDRO  
COMPLETA NEGRO-  
(classic)

IT DM-200 NEGRO 14-18 /  
IT TC-200 14-16 / IT TC-200  
BLANCA 16-18 /IT TC-200  
NEGRA 18/DI COVALT-300  
18-20



### CAB-038

CABEZA DE CILINDRO  
COMPLETA-(classic)

IT DM-250- 20-23



### CAB-017

CABEZA DE CILINDRO  
COMPLETA NEGRO-  
(classic)

IT FT-125 09-12/IT FT-125  
CLASICA 12-16/IT FT-125  
DELIVERY 14-16/IT FT-125  
PLATA 17/IT FT-125 RJ 13-18



### CAB-018

CABEZA DE CILINDRO  
COMPLETA PLATA-  
(classic)

IT FT-125 09-12/IT FT-125  
CLASICA 12-16/IT FT-125  
DELIVERY 14-16/IT FT-125  
PLATA 17/IT FT-125 RJ 13-18



### CAB-020

CABEZA DE CILINDRO  
COMPLETA PLATA-  
(classic)

IT FT-150 06-08



### CAB-021

CABEZA DE CILINDRO  
COMPLETA NEGRO-  
(classic)

IT FT-150 14-16 /IT FT-150 GT  
11-13/VN LITHIUM-150 2.0  
17-21/VN RYDER-150 3.0 19-  
21/VN EXPRESS-150 17-21/  
VN PROTON-150 15-17/VN  
WORKMAN-150 15-17



### CAB-CGG-02

CABEZA DE CILINDRO  
COMPLETA NEGRO-  
(classic)

IT FT-150 S 15-18/IT FT-150 TS  
16-18/IT FT-150 DELIVERY  
15-18/IT DT-150 CLASICA 17-  
18/IT DT-150 DELIVERY 17-18



Linea de Motor

MOTOR LINE

LESSIA  
Motorcycle Products

#SomosPartedeTuMoto

LESSIA  
Motorcycle Products



### CAB-GYG-04

CABEZA DE CILINDRO  
COMPLETA PLATA-  
(classic)

VN ATOM-170 24/IT WS-  
175 12-18/IT GTS-175 10-14/  
IT GTS-175 LED 13-15/IT  
GTS-175 LED CAJA 13-15/IT  
MODENA-175 18-19/IT GCS-  
175 15-18



### CAB-037

CABEZA DE CILINDRO  
COMPLETA NEGRO-  
(classic)

VN ROCKETMAN-250 19-  
22/VN ROCKETMANS-250  
21-22/VN ROCKETMAN  
CR-250 21-22/VN  
CROSSMAX-250 19-22/  
VN CROSSMAX PRO-250  
21-22/VN SCREAMER-250  
22/VN FALKON-250 21-22/



### CAB-039

CABEZA DE CILINDRO  
COMPLETA

VN RYDER 5.0-190 23-24/  
VN RYDER 3.0-150 20-22/  
VN LITHIUM 4.0-150 20-22/  
VN XPRESS-150 16-22/VN  
WORKMAN-150 20-22



### CAB-040

CABEZA DE CILINDRO  
COMPLETA

VN CYCLONE-200 21-22/VN  
URBAN 3.0-200 19-22



### CAB-041

CABEZA DE CILINDRO  
COMPLETA

VC XEVERUS-250



### CAR-031

CARBURADOR-(Rudos  
Biker)

BJ BOXER-150



### CAR-032

CARBURADOR-(Rudos  
Biker)

BJ NS-200



### CAR-023

CARBURADOR-(Rudos  
Biker)

HO CARGO-150



Linea de Motor

MOTOR LINE

LESSIA  
Motorcycle Products

#SomosPartedeTuMoto



### CAR-038

CARBURADOR-(classic)

IT 125-FL 19-22/IT 125-FL  
PAR 19-20



### CAR-009

CARBURADOR-(classic)

IT 150-SZ 16-18 /IT 150-Z 14-  
20 /IT 170-Z 16-18



### CAR-SAE-01

CARBURADOR-(classic)

IT AT-110 14-16 /IT AT-  
110 SPORT 11-15 / IT  
ARGENTA-110 05-13



### CAR-014

CARBURADOR-(classic)

IT AT-110 RT 12-14 /IT AT-  
110 RT LED 14-16 /IT AT-  
110 RT CON LED 16-20/  
DI METRO-120 20-21/DI  
GALAXY-120 20



### CAR-CGF-A

CARBURADOR-(classic)

IT 125-Z 16-20 /IT DT-125  
CLASICA 17-19 /IT DT-125  
DELIVERY 17-20 /IT DT-125  
SPORT 17-20 /IT FORZA-125  
05-12 /IT FT-125 CLASICA  
12-16 /IT FT-125 DELIVERY  
14-16 /IT FT-125 PLATA 17 /IT  
FT-125 ROJA 13-18 /IT FT-125  
ROJA NUEVA 18-19 /IT FT-  
125 SPORT 12-15 /IT FT-125



### CAR-008

CARBURADOR-(classic)

IT 250-Z 14-17 /IT 250-  
Z NEGRA 17-19/VN  
TORNADO-250 17-20/  
VN STORM-250 17-20/VN  
ROCKETMAN-250 20-21



### CAR-034

CARBURADOR-(classic)

IT AT-110 ROJA 17-19 /IT X-110  
17-19 /IT XT110-RT II 17-19



### CAR-035

CARBURADOR-(classic)

IT AT-125 17-19/DI  
MONKEY-125 20-21





### CAR-036

#### CARBURADOR-(classic)

IT ATV-180 16-20/DI  
SUPER ROCKY-150 19/DI  
EXTREME-200 20-21



### CAR-015

#### CARBURADOR-(classic)

IT CS-125 14-18 / IT CS-125  
LED 13-16 /IT DS-125 05-20 /  
IT CITY-125 05-13 /IT X-125 G  
19-20 /IT X125 GTS 19-20 /IT  
XS-125 10-18 /IT VITALIA-125  
16-20



### CAR-037

#### CARBURADOR-(classic)

IT DM-125 17-19



### CAR-016

#### CARBURADOR-(classic)

IT DM-150 10-19 /IT RC-150  
09-17/DI U5-150 20/DI MAX  
2-175 19



### CAR-017

#### CARBURADOR-(classic)

IT DM-200 14-17 /IT RC-  
200 09 /IT TX-200 07-08/DI  
HEAVY-200 19-20



### CAR-039

#### CARBURADOR-(classic)

IT DM-250 16-22/IT DM-  
250X 22



### CAR-GYG-01

#### CARBURADOR-(classic)

IT DS-150 06-20/IT DS-150G  
18-20/IT DS-150 VE 18-19/  
IT DS-150 NE 13-15/IT GS-  
150 10-13/IT GS-150 C/LED  
13-15/IT GSC-150 LED CAJA  
14-15/IT GS-150 LED ELITE  
15-17/IT TRN-150 16-19/IT  
VITALIA-150 15-20/IT WS-150  
08-18/IT WS-150 NF 13-14/IT  
WS-150 SP 17-18/IT XW-150



### CAR-024

#### CARBURADOR-(classic)

IT DT-110 DELIVERY 16-20 /  
IT FT-115 16-19



Linea de Motor

MOTOR LINE

LESSIA  
Motorcycle Products

#SomosPartedeTuMoto

LESSIA  
Motorcycle Products



### CAR-CGG-A

CARBURADOR  
AHOGADOR CHICOTE-  
(classic)

IT DT-150 CLASICA 17 /IT  
DT-150 DELIVERY 17 /IT FT-  
150DELIVERY 15/IT FT-150S  
15-16 / IT FT-150TS 16-17



### CAR-018

CARBURADOR-(classic)

IT DT-200 SPORT 17-20 /  
IT FT-200 14-15 /IT FT-200  
AMARILLA 15-17 /IT FT-180  
13-18 /IT RT-180 11-13 /IT  
FIERA-200 18-20



### CAR-001

CARBURADOR-(classic)

IT DT-90 17 /IT STRADA-70  
05-08 /IT ST-90 09-18



### CAR-004

CARBURADOR-(classic)

IT EX-200 05-08 /IT RT-200  
09-13 /IT RT-200 NEGRO 13-  
15/IT 250Z 19-21



### CAR-033

CARBURADOR-(classic)

IT RT-250 16-20



### CAR-006

CARBURADOR-(classic)

IT TC-200 14-16 /IT TC-250  
15-19 /IT TC-200 BLANCA  
16-18 /IT C-200 CARABELA /  
IT BG-200 BENGALA



### CAR-040

CARBURADOR

SK GN-125 94-01



### CAR-011

CARBURADOR-(classic)

VN XPRESS-150 16-23/IT DT-  
150CL 17-24/IT DT-150DEL  
17-24/IT FT-150DEL 15-18/  
IT FT-150S 15-18/IT FT-150TS  
16-24



Linea de Motor

MOTOR LINE

LESSIA  
Motorcycle Products

#SomosPartedeTuMoto

LESSIA  
Motorcycle Products



### CAR-022

CARBURADOR-(Rudos Biker)

YA YBR-125



### RCA-A001

AHOADOR ELECTRONICO CARBURADOR-(classic)

MOTONETAS CHINAS 125 Y 150 08-20



### CEN-GYD-01

CENTRIFUGO VARIADOR COMPLETO-(classic)

HO TITI-100 08



### CEN-004

CENTRIFUGO DE VARIADOR COMPLETO -(Classic)

IT ATV-200 20-24



### CEN-GYM-01

CENTRIFUGO VARIADOR COMPLETO-(Gold)

IT CS-125 14-18 / IT CS-125 LED 13-16 / IT D-125 16-20 / IT DS-125 09-20 / IT DS-150 06-20 / IT DS-150 G 18-20 / IT DS-150 VERDE 18-19 / IT DS-150 NEGRO 13-15 / IT CITY-125 05-13 / IT GS-150 10-13 / IT GS-150 CON LED 13-14 / IT GS-150 LED CAJA 14-15



### CEN-005

CENTRIFUGO VARIADOR COMPLETO-(RUDOS BIKER)

YA RAY-ZR



### GRA-001

RESBALON PARA CENTRIFUGO-(classic)

IT ATV-150 06-11 / IT ATV-150 SPORT 11-12 / IT ATV-150 SPORT C / REVERSA12-17 / IT CS-125 14-17 / IT CS-125 LED 13



### ROD-001

RODILLOS DE CENTRIFUGO-(classic)

IT ATV-150 06-11 / IT ATV-150 SPORT 11-12 / IT ATV-150 SPORT C / REVERSA 12-17 / IT CS-125 14-17 / IT CS-125 LED 1/VN ATOM-150 14-18 / VN TERRA-150 15-20 / VN PHANTOM-150 ZX 15-17 / VN PHANTOM-150 15-17 / VN TERRA-150 10-15 / VN HOT



Linea de Motor

MOTOR LINE

LESSIA  
Motorcycle Products

#SomosPartedeTuMoto

LESSIA  
Motorcycle Products



### ROD-004

RODILLO DE  
CENTRIFUGO

IT ATV-200 20-23



### ROD-003

RODILLOS DE  
CENTRIFUGO RACING 10  
g-(classic)

MOTONETA/ VN  
PHANTOM-150 15-17/ VN  
TERRA-150 10-15/ VN HOT  
ROD-150 15-19



### CEN-001

CENTRIFUGO VARIADOR  
COMPLETO-(classic)

VN ATOM-170 24/ IT GSC-  
175 15-17/ IT GTS-175 10-14/  
IT GTS-175C/ LEDS 13-15 / IT  
GTS-175 LED CAJA 14-15/ IT  
TRN-175 16/ IT TS-170 09/ IT  
WS-175 12-18/ IT WS-175SP  
18-20/ DI SUPER ROCKY-150  
19/ DI EXTREME-200 20-21



### CIG-017

CIGÜEÑAL COMPLETO-  
(Rudos Biker)

BJ BOXER-150



### CIG-038

CIGÜEÑAL COMPLETO

BJ NS-200/ BJ RS-200/ BJ  
AS-200



### CIG-035

CIGÜEÑAL COMPLETO

VN CYCLONE-150 16-22 / VN  
XPRESS-150 16-22



### CIG-013

CIGÜEÑAL COMPLETO-  
(Rudos Biker)

HO CARGO-150 GL



### CIG-016

CIGÜEÑAL COMPLETO-  
(Rudos Biker)

HO CG-125 TOOL



Linea de Motor

MOTOR LINE

LESSIA  
Motorcycle Products

#SomosPartedeTuMoto

LESSIA  
Motorcycle Products



### CIG-024

#### CIGÜEÑAL COMPLETO- (classic)

IT 125-FL 19-20 /IT 125-FL  
PARRILLA LARGA 19-20



### CIG-018

#### CIGÜEÑAL COMPLETO- (classic)

IT 125-Z 16-20 /IT RC-125 20



### CIG-019

#### CIGÜEÑAL COMPLETO- (classic)

IT 150-SZ 16-18 /IT 150-Z 14-  
20 /IT DM-150 ROJA 18-20 /  
IT DT-150 CLASICA 17-18 /  
IT DT-150 DELIVERY 17-18 /  
IT FT-150 DELIVERY 17-18 /IT  
FT-150 S 15-18 /IT FT-150 TS  
16-18 /IT RC-150 16-20



### CIG-014

#### CIGÜEÑAL COMPLETO- (classic)

IT 170-Z 16-18



### CIG-032

#### CIGÜEÑAL COMPLETO

IT 200-Z 19-23



### CIG-021

#### CIGÜEÑAL COMPLETO- (classic)

IT 250-SZ 15 /IT DT-250  
SPORT 20 /IT FIERA-250 18-  
19 /IT FT-250 15-16 /IT FT-250  
TS 16-19 /IT TC-250 15-20



### CIG-012

#### CIGÜEÑAL COMPLETO- (classic)

IT 250-Z 14-17 /IT 250-Z  
NEGRA 17-18



### CIG-010

#### CIGÜEÑAL COMPLETO- (classic)

IT AT-110 NEGRA 16-18 /IT  
AX-110 16 /IT FT-110 10-16 /  
IT XT-110 11-15 /IT XT-110  
GRAFITO 13-17



Linea de Motor

MOTOR LINE

LESSIA  
Motorcycle Products

#SomosPartedeTuMoto

LESSIA  
Motorcycle Products



### CIG-009

#### CIGÜEÑAL COMPLETO- (classic)

IT AT-110 RT 12-14 / IT AT-110 RT LED 14-16 / IT AT-110 RT CON LED 16-20



### CIG-023

#### CIGÜEÑAL COMPLETO- (classic)

IT AT-125 17-19 / IT AT-125 RT 20



### CIG-GYM-01

#### CIGÜEÑAL COMPLETO- (classic)

IT ATV-150 05 / IT CS-125 14-17 / IT CS-125 LED 13-16 / IT D-125 16-17 / IT DS-125 17 / IT DS-150 14-17 / IT DS-150 NEGRO / VN ATOM-150 14-18



### CIG-022

#### CIGÜEÑAL COMPLETO- (classic)

IT ATV-150 SPORT 11-12 / IT ATV-150 CON REVERSA 19-20 / IT ATV-150 SPORT C / REVERSA 12-19



### CIG-001A

#### CIGÜEÑAL COMPLETO 63/28X1/P5 MEDIDA EXTERIOR 72 mm-(classic)

IT DM-150 10-19 / IT DT-150 SPORT 17-18 / IT FORZA-150 09-13 / IT FT-150 14-16 / IT FT-150 AZULP 13-16 / IT FT-150 G 16-18 / IT FT-150 G NEGRA 18-20 / IT FT-150 GT 11-13 / IT FT-150 GT GRAFITO 13-14 / IT FT-150 GTI 15-17 / IT FT-150



### CIG-001

#### CIGÜEÑAL COMPLETO 63/28/P5 MEDIDA EXTERIOR 68mm-(classic)

IT DM-150 10-19 / IT DT-150 SPORT 17-18 / IT FORZA-150 09-13 / IT FT-150 14-16 / IT FT-150 AZULP 13-16 / IT FT-150 G 16-18 / IT FT-150 G NEGRA 18-20 / IT FT-150 GT



### 11-13 / IT FT-150 GT

CIG-001.jpg



### CIG-025

#### CIGÜEÑAL COMPLETO- (classic)

IT DM-150 SPORT 19-20



Linea de Motor

MOTOR LINE

LESSIA  
Motorcycle Products

#SomosPartedeTuMoto

LESSIA  
Motorcycle Products



### CIG-011

#### CIGÜEÑAL COMPLETO- (classic)

IT DM-200 07-19 /IT DM-200  
SPORT 19 /IT DT-200 SPORT  
17-19 /IT FIERA-200 18-19 /  
IT FT-200 14-15 /IT FT-200  
AMARILLA 15-17



### CIG-030

#### CIGÜEÑAL COMPLETO

IT DM-250 20-23/IT DM-  
250X 22-23



### CIG-CGF-01

#### CIGÜEÑAL COMPLETO- (classic)

IT DT-125 CLASICA 17 /IT DT-  
125 DELIVERY 17 /IT DT-125  
SPORT 17 /IT FORZA 125 05-  
12 /IT FT-125 CLASICA 12-16



### CIG-003

#### CIGÜEÑAL COMPLETO- (classic)

IT EX 200 07-08 /IT RT-200  
09-16 /IT RT-200 GP 17 /IT  
RT-200 NEGRO 13-15



### CIG-CGG-01

#### CIGÜEÑAL COMPLETO- (classic)

IT FORZA-150cc PERNO  
15mm



### CIG-006

#### CIGÜEÑAL COMPLETO- (classic)

IT FT-180 13-14 / IT FT-180 19-  
20 /IT RT-180 11-13



### CIG-005

#### CIGÜEÑAL COMPLETO- (classic)

IT GSC-175 15-18 /IT GTS-175  
10-14 /IT GTS-175 CON LEDS  
13-15 /IT GTS-175 LED CAJA  
14-15 /IT MODENA-175 18-20  
/IT TRN-175 16 /IT TS-170 09  
/IT WS-175 12-18 /IT WS-175  
SPORT 18-20



### CIG-031

#### CIGÜEÑAL COMPLETO

IT RT-250 16-20/IT DM-250  
16-18/IT 250-Z 19-23/IT RT-  
250SP 20-23



Linea de Motor

MOTOR LINE

LESSIA  
Motorcycle Products

#SomosPartedeTuMoto

LESSIA  
Motorcycle Products



### CIG-026

#### CIGÜEÑAL COMPLETO- (classic)

IT VORT-X 300 17-22/IT  
VORT-X 300R 21-22



### CIG-027

#### CIGÜEÑAL COMPLETO- (classic)

VN ROCKETMAN-250  
19-22/VN ROCKETMAN-  
250SP 21-22/VN  
ROCKETMAN-250CR 21-22/  
VN CROSSMAX-250 19-22/  
VN CROSSMAX-250PRO  
21-22/VN SCREAMER-250  
22/VN FALKON-250 21-22/  
VN STORM 250 21-22/VN



### CIG-034

#### CIGÜEÑAL COMPLETO

VN URBAN-200



### CIG-029

#### CIGÜEÑAL COMPLETO

VN CYCLONE-200 21-23



### CIG-033

#### CIGÜEÑAL COMPLETO

VC XEVERUS-250 21-23



### CIG-041

#### CIGÜEÑAL COMPLETO

VC XEVERUS-200 20-22



### CIG-007

#### CIGÜEÑAL COMPLETO- (classic)

YA YBR-125 E 00-08



### CIG-037

#### CIGÜEÑAL COMPLETO

YA FZ-16 11-17/YA FZ-16 2.0  
20-22



Linea de Motor

MOTOR LINE

LESSIA  
Motorcycle Products

#SomosPartedeTuMoto

LESSIA<sup>®</sup>  
Motorcycle Products



### CLU-035

CLUTCH COMPLETO-  
(Rudos Biker)

BJ BOXER-150



### CLU-009

CLUTCH COMPLETO  
ARRANQUE DE PEDAL-  
(classic)

HO TITAN-150



### CLU-011

CLUTCH COMPLETO  
ARRANQUE  
ELECTRONICO-(classic)

HO TITAN-150



### CLU-045

CLUTCH COMPLETO-  
(classic)

IT 125-FL 19-21/IT 125-FL  
PARRILLA LARGA 19-20



### CLU-044

CLUTCH COMPLETO-  
(classic)

IT 200-Z 19-22



### CLU-008

CLUTCH COMPLETO-  
(classic)

IT 250-Z 14-17 /IT 250-Z  
NEGRA 17-19 /IT DM-200  
14-23 /IT DM-200 SPORT  
19-21 /IT TC-200 14-16 /IT  
TC-200 BLANCA 16-18 /IT  
TC-200 NEGRA 18-20 /IT TC-  
250 15-19 /IT 250-SZ 23 /IT  
250-SZ 15 /IT DT-200 SPORT  
17-20 /IT DT-250 SPORT



### CLU-001

CLUTCH COMPLETO-  
(classic)

IT AR-110 15 /IT AT-110 14-16  
/IT AT-110 SPORT 11-15 /IT  
ARGENTA-110 05-13



### CLU-036

CLUTCH COMPLETO-  
(classic)

IT AT-110 NEGRA 16-18 /IT  
AT-110 ROJA 17-19 /IT AX-110  
16 /IT X-110 17-19 /IT XT-110 11-  
15 /IT XT-110 GRAFITO 13-15



Linea de Motor

MOTOR LINE

LESSIA  
Motorcycle Products

#SomosPartedeTuMoto

LESSIA  
Motorcycle Products



### CLU-048

CLUTCH COMPLETO-  
(classic)

IT AT-110RT 12-14/IT AT-110RT  
LED 14-22



### CLU-043

CLUTCH PRIMARIO-  
(classic)

IT AT-125 17-19 /IT AT-125 RT  
20



### CLU-042

CLUTCH COMPLETO-  
(classic)

IT ATV C/REVERSA 14-18 /IT  
ATV-250 NEGRA 18-20



### CLU-049

CLUTCH COMPLETO-  
(Classic)

IT ATV-200 20-24



### CLU-040

CLUTCH COMPLETO-  
(classic)

IT ATV-250 C/REVERSA 14-  
18 /IT ATV-250 NEGRA 18



### CLU-GYM-01

CLUTCH COMPLETO-  
(classic)

IT D-125 16-18 /IT DS-125  
17-18 /IT DS-150 16-18 /IT DS-  
150G 18 /IT DS-150 VERDE  
18 /IT DSG-125 17-18 /VN  
ATOM-150 14-18



### CLU-039

CLUTCH COMPLETO-  
(classic)

IT DM-125 17-19/VN  
XPRESS-150 16-23/VN  
WORKMAN-150 20-23/VN  
RYDER-150 3.0 20-23/VN  
LITHIUM-150 4.0 20-23



### CLU-037

CLUTCH COMPLETO-  
(classic)

IT DT-125 12-16



Linea de Motor

MOTOR LINE

LESSIA  
Motorcycle Products

#SomosPartedeTuMoto

LESSIA  
Motorcycle Products



### CLU-CGM-01

CLUTCH COMPLETO-  
(classic)

IT DT-125 CLASICA 17 /IT DT-125 DELIVERY 17 /IT DT-125 SPORT 17 /IT FORZA 125 11-12 /IT FT-125 CLASICA 12-16



### CLU-038

CLUTCH COMPLETO-  
(classic)

IT DT-150 SPORT II 17-20 /IT FIERA 150 18-19



### CLU-006

CLUTCH COMPLETO-  
(classic)

IT DT-90 17 / IT STRADA-70 05-08 /IT ST-90 09-18



### CLU-016

CLUTCH COMPLETO-  
(classic)

IT FT-110



### CLU-021

CLUTCH COMPLETO-  
(classic)

IT RT-200 09-16 /IT FT-180 13-17 /IT RT-180 11-13 /IT RT-200 GP 17-18 /IT RT-200 NEGRO 13-15



### CLU-047

CLUTCH COMPLETO-  
(classic)

IT RT-250 16-20 /IT RT-250SP 20-24 /IT 250-Z 19-24



### CLU-050

CLUTCH COMPLETO

MOTOCARRO 200CC



### CLU-017

CLUTCH COMPLETO-  
(classic)

VN ATOM-170 24 /IT GTS-175 /IT GSC-175 /IT GTS-175 LED /IT TRN-175 /IT WS-175



Linea de Motor

MOTOR LINE

LESSIA  
Motorcycle Products

#SomosPartedeTuMoto

LESSIA<sup>®</sup>  
Motorcycle Products



### CLU-013

CLUTCH COMPLETO-  
(classic)

YA YBR-125



### DIS-A006

DISCOS DE CLUTCH-  
(Rudos Biker)

BJ BOXER-150



### DIS-A003

DISCOS DE CLUTCH-  
(classic)

HO TITAN-150



### DIS-A009

DISCO DE CLUTCH-  
(classic)

IT 125-FL 19-21 /IT 125-FL  
PARRILLA LARGA 19-21



### DIS-A007

DISCOS DE CLUTCH-  
(classic)

IT 125-Z 16-18 /IT 150-SZ 16-18  
/IT 150-Z 14-16 /IT 250-SZ  
15 /IT 250-Z 14-17 /IT 250-Z  
NEGRA 17-18 / IT DM-125  
17-21



### DIS-A002

DISCOS DE CLUTCH-  
(classic)

IT 250-SZ 15 /IT FT-180 13-17  
/IT FT-200 14-15 /IT FT-200  
AMARILLA 15 /IT FT-250 15-  
16 /IT FT-250 TS 16-17



### DIS-A004

DISCOS DE CLUTCH-  
(classic)

IT AR-110 15 /IT AT-110 RT  
LED 14-16 /IT AT-110 SPORT  
11-15 /IT ARGENTA-110 05-13/  
IT AT-110 SPORT 11-15

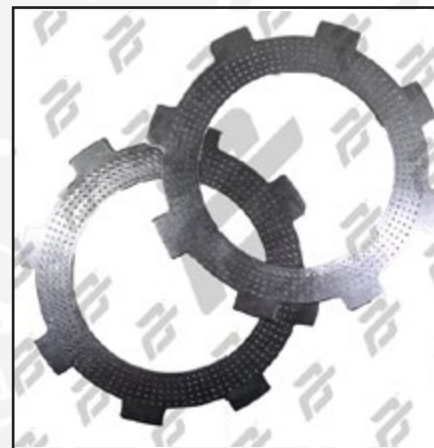

### DIS-A005

DISCOS DE CLUTCH-  
(classic)

IT DT-110 DELIVERY 16-18 /IT  
FT-115 16-18



Linea de Motor

MOTOR LINE

LESSIA  
Motorcycle Products

#SomosPartedeTuMoto

LESSIA  
Motorcycle Products



**DIS-A001**

DISCO DE CLUTCH-  
(classic)

IT FT-110 10-16



**DIS-A010**

DISCOS DE CLUTCH-  
(classic)

IT VORTX-200 18-21

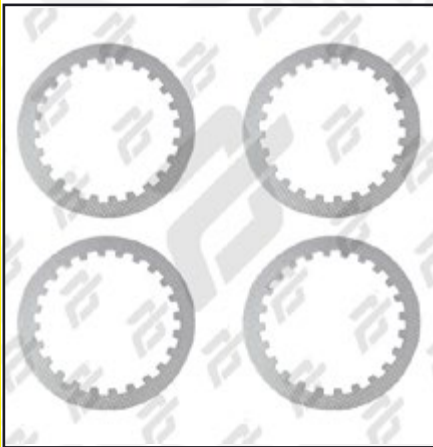

**DIS-A008**

DISCOS DE CLUTCH-  
(classic)

YA YBR-125



**PAS-016**

PASTAS DE CLUTCH-  
(Rudos Biker)

BJ BOXER-150



**PAS-017**

PASTAS DE CLUTCH-  
(Rudos Biker)

BJ NS-200



**PAS-020**

PASTAS DE CLUTCH-  
(classic)

IT 125-FL 19-20 /IT 125-FL  
PARRILLA LARGA 19-20

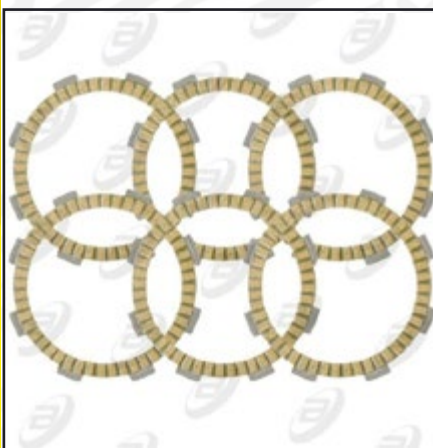

**PAS-008**

PASTAS DE CLUTCH  
PAPER BASE-(Gold)

IT 150S-Z 16-17 /IT 150-Z 14-  
16 /IT 170-Z 16-17 / IT 250S-Z  
15 /IT 250-Z 14-17 / IT 250-Z  
NEGRA 17 /IT DM-250 16 /  
UNIVERSAL



**PAS-CGM-01**

PASTAS DE CLUTCH-  
(classic)

IT 150-SZ 16-18 /IT 150-Z 14-  
16 /IT 250-SZ 15 /IT 250-Z 14-  
17 /IT 250-Z NEGRA 17-18 /IT  
DM-150 10-18 /IT DM-200 14



Linea de Motor

MOTOR LINE

LESSIA  
Motorcycle Products

#SomosPartedeTuMoto

LESSIA  
Motorcycle Products



### PAS-006

#### PASTAS DE CLUTCH A-LEVEL-(Gold)

IT 150-SZ 16-18 /IT 150-Z 14-16 /IT 250-SZ 15 /IT 250-Z 14-17 /IT 250-Z NEGRA 17-18 /IT DM-150 10-18 /IT DM-200 14



### PAS-004

#### PASTAS DE CLUTCH- (classic)

IT 250-SZ 16 /IT FT-180 13-18 /IT FT-200 14-15 /IT FT-200 AMARILLA 15-17 /IT FT-250 15-16 /IT FT-250 TS 16-18 /IT RT-180 11-13 /IT TC-200 14-16



### PAS-018

#### PASTAS DE CLUTCH- (classic)

IT AT-110 20-22 /IT AT-110 NEGRA 16-18 /IT AT-110 ROJA 17-20 /IT AX-110 16 /IT



### T-REX70 14-15 /IT

PAS-018.jpg



### PAS-013

#### PASTAS DE CLUTCH- (classic)

IT AT-110 NEGRA 16-18 /IT AT-110 ROJA 17-18 /IT AX-110 16 /IT T-REX-70 14-15 /IT X-110 17-18 /IT XT-110 GRAFITO



### PAS-023

#### PASTAS DE CLUTCH- (classic)

IT AT-110RT 12-14 /IT AT-110RT LED 14-21 /IT AT-110SP 11-15 /IT AT-125 17-20 /IT AT-125RT 20-21 /IT ARGENTA-110 05-13 /IT AR110



### PAS-GYM-02

#### PASTAS DE CLUTCH- (classic)

IT CS-125 /IT DS-150 /IT XS-150 /IT GS-150 /IT XS-125 /IT WS-150 /VN ATOM-150 14-18



### PAS-019

#### PASTAS DE CLUTCH- (classic)

IT FT-110 10-16



Linea de Motor

MOTOR LINE

LESSIA  
Motorcycle Products

#SomosPartedeTuMoto

LESSIA  
Motorcycle Products



**PAS-007**

PASTAS DE CLUTCH  
PAPER BASE-(Gold)

IT FT-125 /IT FT-150 /HO CG-  
125 /HO CG-150



**PAS-011**

PASTAS DE CLUTCH  
PAPER BASE-(Gold)

IT ST-70 /IT ST-90 CALIDAD  
GOLD



**PAS-021**

PASTAS DE CLUTCH-  
(Rudos Biker)

IT V-200 18-20

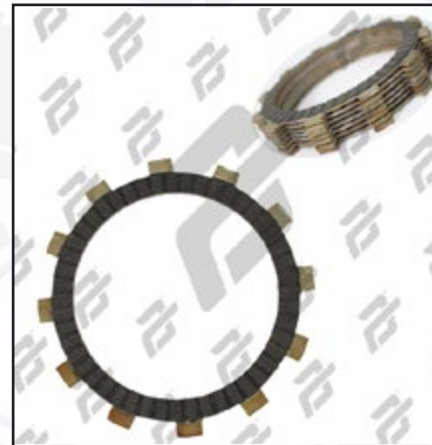

**PAS-024**

PASTAS DE CLUTCH-  
(classic)

IT VORTX-300 17-21/IT  
VORTX-300R 21



**PAS-022**

PASTAS DE CLUTCH-  
(Gold)

IT VX-250 ADV 16-18/IT VX-  
250 EFI 18-20



**PAS-025**

PASTAS DE CLUTCH  
(CLASSIC )

MOTOCARRO 200CC



**PAS-026**

PASTAS DE CLUTCH (   
RUDOS BIKER)

SK GIXXER-150



**PAS-003**

PASTAS DE CLUTCH-  
(classic)

YA FZ-16 /YA R-15 12-13



Linea de Motor

MOTOR LINE

LESSIA  
Motorcycle Products

#SomosPartedeTuMoto

LESSIA  
Motorcycle Products



### PAS-005

PASTAS DE CLUTCH-  
(classic)

YA YBR-125



### PLC-001

PLACA DE CLUTCH-  
(classic)

IT 125-Z 16-18 /IT 150-SZ 16-18  
/IT 150-Z 14-16 / IT 250-SZ  
15 /IT 250-Z 14-17 /IT 250-Z  
NEGRA 17-18 /IT DM-150



### COP-003

COPE DE CARBURADOR  
PIPETA-(classic)

HO CARGO 125 06-10



### COP-CGG-04

COPE DE CARBURADOR  
PIPETA-(classic)

HO CARGO CG-125



### COP-002

COPE DE CARBURADOR  
PIPETA-(classic)

HO CARGO TITAN/ IT RC-  
150AI



### COP-004

COPE DE CARBURADOR  
PIPETA-(classic)

IT 125-Z 16-22/IT 150-Z14-22/  
IT 150-SZ 16-18/IT 170-Z 16-18



### COP-SAE-04

COPE DE CARBURADOR  
PIPETA-(classic)

IT 250-SZ 15 /IT DT-200  
SPORT 17 /IT FT-180 13-17 /  
IT FT-200 14-15 /IT FT-200  
AMARILLA 15 /IT FT-250 15-  
16 /VC COVALT-300 18-20



### COP-014

COPE DE CARBURADOR  
PIPETA-(classic)

IT 250-Z 14-17 /IT 250-Z NE  
17-19



Linea de Motor

MOTOR LINE

LESSIA  
Motorcycle Products

#SomosPartedeTuMoto

LESSIA<sup>®</sup>  
Motorcycle Products



### COP-005

#### COPLE DE CARBURADOR PIPETA-(classic)

IT AR-110 15 /IT AT-110  
NEGRA 16-17 /IT AX-110 16  
/IT XT-110 11-15 /IT XT-110  
GRAFITO 13-17 /IT STRADA  
70 05-08



### COP-SAE-03

#### COPLE DE CARBURADOR PIPETA-(classic)

IT AT-110 SP 11-15/IT AT-110  
14-16/IT ARGENTA-110 05-  
13/KU GALAXY-110/GT-110  
ALESSIA 16



### COP-012

#### COPLE DE CARBURADOR PIPETA-(classic)

IT AT-125 17-19



### COP-011

#### COPLE DE CARBURADOR PIPETA-(classic)

IT ATV-250 C/REVERSA 14-  
18 /IT ATV-250NE 18-20



### COP-GYG-01

#### COPLE DE CARBURADOR PIPETA-(classic)

IT CS-125 14-17 /IT CS-125  
LED 13-16 /IT D-125 16-17 /IT  
DS-125 17 /IT DS-150 14-17 /  
IT DS-150 NEGRO 13-15/DI  
ADVENTURE-150 19-21/DI  
ALIEN R-150 19-21



### COP-CGG-03

#### COPLE DE CARBURADOR PIPETA-(classic)

IT DM-150 10-18/CUSTOM  
CHINAS 150cc/IT TC-200  
14-16/IT TC-200 BCA 16-18/IT  
TC-200 NE 18-20/IT TC-250  
15-20/IT RT-200 05-16/IT RT-  
200 GP 17-20/IT RT-200 20/  
IT EX-200 05-08/IT RT-200  
NE 13-15/IT RC-150 09-13/IT  
RC-150 GT 12-15



### COP-013

#### COPLE DE CARBURADOR PIPETA-(classic)

IT DM-200 14-20 /IT DM-  
200SP 19-20 / IT DM-250  
16-18



### COP-CGG-02

#### COPLE DE CARBURADOR PIPETA-(classic)

IT DT-150 SPORT 17-18 /  
IT DT-150 SPORT II 17 /IT  
FORZA-125 07-12 /IT FORZA  
150 06-13 /IT FIERA 150 18 /IT  
FT-125 12-16



Linea de Motor

MOTOR LINE

LESSIA  
Motorcycle Products

#SomosPartedeTuMoto

LESSIA  
Motorcycle Products



### COP-015

COPE DE CARBURADOR  
PIPETA-(classic)

IT RC-150 16-19/DI US-150 /  
DI MAX 2-175



### ESC-C005

COPE DE ESCAPE  
COMPLETO-(classic)

IT RC-150/ IT FT-125/IT FT-  
150 / KU CLASSIC-125 / KU  
DELIVERY MAX-150 06-13



### COP-017

COPE DE CARBURADOR  
PIPETA-(classic)

IT SPTFIRE-250 23



### COP-CCG-01

COPE DE CARBURADOR  
PIPETA-(classic)

SK EN-125 / SK GN-125 03-  
07



### COP-016

COPE DE CARBURADOR  
PIPETA-(classic)

SK EN-125 HU 07-20



### COP-008

COPE DE CARBURADOR  
PIPETA-(Rudos Biker)

YA YBR-125



### CVE-002

CAJA DE VELOCIDADES  
ENGRANE PRIMARIO Y  
SECUNDARIO-(Rudos  
Biker)

BJ BOXER-150



### CVR-001

CAJA DE VELOCIDADES  
REVERSA CLASSIC

MOTOCARRO 200cc



Linea de Motor

MOTOR LINE

LESSIA  
Motorcycle Products

#SomosPartedeTuMoto

LESSIA  
Motorcycle Products



### CVE-029

CAJA DE VELOCIDADES  
ENGRANE PRIMARIO Y  
SECUNDARIO

MOTOCARRO 200cc



### CVE-012

CAJA DE VELOCIDADES  
ENGRANE PRIMARIO Y  
SECUNDARIO-(Rudos  
Biker)

HO CARGO-150



### CVE-004

CAJA DE VELOCIDADES  
ENGRANE PRIMARIO Y  
SECUNDARIO-(Rudos  
Biker)

HO CGL-125 TOOL



### CVE-018

CAJA DE VELOCIDADES  
ENGRANE PRIMARIO Y  
SECUNDARIO-(classic)

IT 125-FL 19-21 / IT 125-FL  
PARRILLA LARGA 19-20



### CVE-014

CAJA DE VELOCIDADES  
ENGRANE PRIMARIO Y  
SECUNDARIO-(classic)

IT 125-Z 16-18



### CVE-013

CAJA DE VELOCIDADES  
ENGRANE PRIMARIO Y  
SECUNDARIO-(Gold)

IT 170-Z 16-18



### CVE-019

CAJA DE VELOCIDADES  
ENGRANE PRIMARIO Y  
SECUNDARIO-(classic)

IT 200-Z 19-22



### CVE-011

CAJA DE VELOCIDADES  
ENGRANE PRIMARIO Y  
SECUNDARIO-(Gold)

IT 250-Z 14-17 /IT 250-Z NE  
17-19



Linea de Motor

MOTOR LINE

LESSIA  
Motorcycle Products

#SomosPartedeTuMoto

LESSIA  
Motorcycle Products



### CVE-001

CAJA DE VELOCIDADES  
ENGRANE PRIMARIO Y  
SECUNDARIO-(classic)

IT AT-110 ROJA 17-19 /IT  
X-110 17-19 /IT XT-110 RT II  
17-19



### CVE-016

CAJA DE VELOCIDADES  
ENGRANE PRIMARIO Y  
SECUNDARIO-(classic)

IT AT-110 SPORT 11-15/IT AT-  
110 14-21 / KU GALAXY-125/  
GT-110 ALESSIA 05-12



### CVE-020

CAJA DE VELOCIDADES  
ENGRANE PRIMARIO Y  
SECUNDARIO-(classic)

IT ATV-250 C/REVERSA 14-  
18 /IT ATV-250 NE 18-20



### CVE-023

CAJA DE VELOCIDADES  
ENGRANE PRIMARIO Y  
SECUNDARIO-(classic)

IT DM-125 17-21



### CVE-010

CAJA DE VELOCIDADES  
ENGRANE PRIMARIO Y  
SECUNDARIO-(classic)

IT DM-150 10-19



### CVE-028

CAJA DE VELOCIDADES  
ENGRANE PRIMARIO Y  
SECUNDARIO

IT DM-150 22-24/ IT DM-  
150RO 18-21



### CVE-003

CAJA DE VELOCIDADES  
ENGRANE PRIMARIO Y  
SECUNDARIO-(classic)

IT DM-200 14-24/IT DM-  
200SP 19-21/IT DM-250X  
22-24/IT DM-250 20-24/VN  
CROSSMAX 250 20-22/VN  
CROSSMAX-250PRO 21-22



### CVE-021

CAJA DE VELOCIDADES  
ENGRANE PRIMARIO Y  
SECUNDARIO-(Gold)

IT DM-250 16-18



Linea de Motor

MOTOR LINE

LESSIA  
Motorcycle Products

#SomosPartedeTuMoto

LESSIA  
Motorcycle Products



### CVE-030

CAJA DE VELOCIDADES  
ENGRANE PRIMARIO Y  
SECUNDARIO

IT DM-250X 22-24 / IT DM-  
250 20-24



### CVE-007

CAJA DE VELOCIDADES  
ENGRANE PRIMARIO Y  
SECUNDARIO-(Gold)

IT DT-125 CLASICA 17-18 /  
IT DT-125 SPORT 17-18 / IT  
DT-150 BASIC 18 / IT FT-125  
ROJA NUEVA 18 / IT FT-  
125TS 16-18



### CVE-015

CAJA DE VELOCIDADES  
ENGRANE PRIMARIO Y  
SECUNDARIO-(classic)

IT DT-150 DELIVERY 17-18 / IT  
150-SZ 16-18 / IT 150-Z 14-16 /  
IT FT-150 DELIVERY 15 / IT  
RC-150AI



### CVE-008

CAJA DE VELOCIDADES  
ENGRANE PRIMARIO Y  
SECUNDARIO-(Gold)

IT DT-150 SPORT 17-18 / IT  
FORZA-150 09-13 / IT FT-150  
14-16 / IT FT-150 AZULP 13-16  
/ IT FT-150G 16-18



### CVE-009

CAJA DE VELOCIDADES  
ENGRANE PRIMARIO Y  
SECUNDARIO-(Gold)

IT DT-200 SPORT 17-18 /  
IT FIERA 200 18 / IT FIERA  
250 18 / IT FT-200 14-15 / IT  
FT-200 AMARILLA 15-17 / IT  
FT-250 15-18



### CVE-006

CAJA DE VELOCIDADES  
ENGRANE PRIMARIO Y  
SECUNDARIO-(Gold)

IT FT-110 10-13



### CVE-017

CAJA DE VELOCIDADES  
ENGRANE PRIMARIO Y  
SECUNDARIO-(classic)

IT RC-200 19-20 / IT  
SPITFIRE-200 19-21



### CVE-022

CAJA DE VELOCIDADES  
ENGRANE PRIMARIO Y  
SECUNDARIO-(Gold)

IT RT-250 16-20



Linea de Motor

MOTOR LINE

LESSIA  
Motorcycle Products

#SomosPartedeTuMoto

LESSIA  
Motorcycle Products



### CVE-027

CAJA DE VELOCIDADES  
ENGRANE PRIMARIO Y  
SECUNDARIO-(classic)

IT SPTFIRE-250 22-23



### CVE-026

CAJA DE VELOCIDADES  
ENGRANE PRIMARIO Y  
SECUNDARIO-(classic)

VN NITROX-200 21-22



### CVE-025

CAJA DE VELOCIDADES  
ENGRANE PRIMARIO Y  
SECUNDARIO-(classic)

VN NITROX-250T2 21-22



### CVE-024

CAJA DE VELOCIDADES  
ENGRANE PRIMARIO Y  
SECUNDARIO-(classic)

VN ROCKETMAN-250 19-  
22/VN THUNDERSTAR-250  
20-22/VN TORNADO-250  
21-22



### CVE-005

CAJA DE VELOCIDADES  
ENGRANE PRIMARIO Y  
SECUNDARIO-(Rudos  
Biker)

YA YBR-125



### EJE-E006

EJE DE CAMBIOS-(Rudos  
Biker)

BJ BOXER-150



### EJE-E014

EJE DE CAMBIOS-(classic)

IT 125-FL 19-20 /IT 125-FL  
PARRILLA LARGA 19-20



### EJE-E011

EJE DE CAMBIOS-(classic)

IT 125-Z 16-20/IT 150-SZ 16-  
18/IT 150-Z 14-20/IT 250-Z  
14-17/IT 250-Z NE 17-19/IT  
DM-125 17-20/IT DM-150 SP  
19-21/IT DM-150 RO 18-20/  
IT DM-200 14-20/IT DM-200  
SP 19-20/IT DM-250 20/IT  
DT-125 CL 17-19/IT DT-125  
SP 17-20/IT DT-150 20/IT DT-  
150 BA 18-20/IT DT-150 CL



Linea de Motor

MOTOR LINE

LESSIA  
Motorcycle Products

#SomosPartedeTuMoto

LESSIA  
Motorcycle Products



### EJE-E016

EJE DE CAMBIOS-(classic)

IT 250-Z 19-21/IT DM-250  
16-18/IT RT-250 16-21/IT DM-  
300 24



### EJE-E009

EJE DE CAMBIOS-(classic)

IT ARGENTA-110 06-13/IT  
AT-110 14-16/IT AT-110 SP  
11-15/IT AT-110RT 12-14/IT AT-  
110RTLED 14-16/IT AT-110RT  
C/LED 16-22/IT AR-110 15



### EJE-E008

EJE DE CAMBIOS-(classic)

IT AT-110 / KURAZAI  
GALAXY 2008



### EJE-E013

EJE DE CAMBIOS-(classic)

IT AT-125 17-19 /IT AT-125 RT  
20



### EJE-E003

EJE DE CAMBIOS-(classic)

IT DM-150 10-19/IT DT-150  
SPORT 17-18/IT FORZA-150  
06-13/IT FT-150 14-16/IT FT-  
150 AZP 13-16/IT FT-150 G  
16-18/IT FT-150 G NE 18-20/IT  
FT-150 GT 11-13/IT FT-150 GT  
GO 13-14/IT FT-150GT115-17/  
IT FT-150 GTS 16-18/IT FT-150  
GTS RO 18-20/VN CROSS  
MAX-200 19-21



### EJE-E015

EJE DE CAMBIOS-(classic)

IT RC-150 09-17/IT RC-150GT  
12-15/IT RC-200 19-21/IT RT-  
200 10-13/VN NITROX-250  
T3 22-24



### EJE-E017

EJE DE CAMBIOS-(Rudos  
Biker)

IT V-200 19-21



### EJE-E018

EJE DE CAMBIOS-(classic)

IT VORT-X300 17-22/IT  
VORT-X300R 21-22





**EJE-E019**

**EJE DE CAMBIOS-(classic)**

VN CROSSMAX PLUS-250 20-22/VN CROSSMAX PRO PLUS-250 21-22/  
VN CYCLONE-150 21-22/  
VN CYCLONE-200 21-22/  
VN FALKON-250 22/VN LITHIUM2.0-150 20-21/  
VN RYDER3.0-150 20-22/  
VN URBAN3.0-150 19-22/  
VN WORKMAN-150 20-22/



**EJE-E020**

**EJE DE CAMBIOS-(Rudos Biker)**

VN ROCKEMAN-250RA 18-22/VN THUNDERSTAR-250 20-22/VN TORNADO-250 21-22/VN WORKMAN-250 20-22



**EJE-E021**

**EJE DE CAMBIOS-(classic)**

VN ROCKETMAN-250 CR 22/VN SCREAMER-250 21/  
VN STORM-250 21-22



**EJE-E005**

**EJE DE CAMBIOS-(Rudos Biker)**

YA YBR-125



**EJE-132**

**EJE DE PEDAL DE ARRANQUE-(Gold)**

IT CS-125 14-17 /IT CS-125 LED 13-16 /IT D-125 16-17 /  
IT DS125 17 /IT DS-150 14-17/  
IT DS-150 NEGRO 13-15 /IT DSG-125 17-21



**EJE-131**

**EJE DE PEDAL DE ARRANQUE CORTO-(classic)**

IT CS-125 14-18/IT CS-125 LED 13-16 /IT D-125 16-21 /IT DS-125 17-19 /IT DS-150 14-21 /  
IT DS-150G 18-21 /IT DSG-125 17-21/IT CITY-125 05-13 /  
IT GS-150 10-13 /IT GSC-150 15-16



**EJE-130**

**EJE DE PEDAL DE ARRANQUE LARGO-(classic)**

IT GSC-175 /IT GTS-175 /  
IT GTS-175 CON LEDS /  
IT GTS-175 LED CAJA /  
IT MODENA-150 /IT MODENA-175 /  
IT TRN-175 /DI TS-170 09/DI ADVENTURE-150 19-21/DI ALIEN R-150 19-21



**EJE-D001**

**EJE DE TRACCION-(classic)**

IT CS-125 14-18 /IT CS-125 LED 13-16 /IT DS-125 17-18 /  
IT DSG-125 17-18 /IT CITY-125 05-13 /IT VGO-125 15-17



Linea de Motor

MOTOR LINE

LESSIA  
Motorcycle Products

#SomosPartedeTuMoto

LESSIA  
Motorcycle Products



### EJE-D003

EJE DE TRACCION-  
(classic)

IT D-125 16-18 /IT  
MODENA-150 18 /IT  
MODENA-175 18 /IT W-150  
17-18 /IT WS-150 10-18 /IT  
WS-150 NF 13-14 /IT WS-150  
10-19



### EJE-D002

EJE DE TRACCION-  
(classic)

IT DS-150 14-21 /IT DS-125  
05-09 /IT GS-150 10-13 /IT  
GSC-150 15-16 /IT GSC-175  
15-18 /IT GTS-175 10-14 /IT  
TRN-150 15-20 /IT TRN-175  
16 /DI TS-170 09 /IT WS-150  
08-11 /IT WS-175 12-18 /DI  
DVENTURE 150 /DI ALIEN  
R 150



### EJE-105

EJE PEDAL DE  
ARRANQUE-(Rudos Biker)

HO CGL-125 TOOL



### EJE-127

EJE PEDAL DE  
ARRANQUE-(classic)

IT 125-FL 19-20 /IT 125-FL  
PARRILLA LARGA 19-20



### EJE-010

EJE PEDAL DE  
ARRANQUE-(classic)

IT 125-Z 16-17 /IT 150S-Z 16-17  
/IT 150-Z 14-16 /IT DM-150  
10-17 /IT DT-125 CLASICA 17 /  
IT DT-125 DELIVERY 17



### EJE-045

EJE PEDAL DE  
ARRANQUE-(classic)

IT 250-SZ 15 /IT DT-200  
SPORT 17-18 /IT FIERA-200  
18 /IT FIERA-250 18 /IT FT-  
180 13-18 /IT FT-200 14-15



### EJE-126

EJE PEDAL DE  
ARRANQUE-(classic)

IT AT-110 20 /IT AT-110 RO 17-  
19 /IT X-110 17-19 /IT XT-110 20  
/IT XT-110RT II 17-19 /IT AT-125  
17-19



### EJE-125

EJE PEDAL DE  
ARRANQUE-(classic)

IT DM-125 17-20 /IT DM-  
150SP 19-20



Linea de Motor

MOTOR LINE

LESSIA  
Motorcycle Products

#SomosPartedeTuMoto

LESSIA  
Motorcycle Products



### EJE-128

EJE PEDAL DE  
ARRANQUE-(classic)

IT DM-150 RO 18-20 /IT  
RT-200 09-13 /IT RT-200 NE  
13-15



### EJE-114

EJE PEDAL DE  
ARRANQUE-(classic)

IT DM-200 14-18/ VN  
ROCKETMAN-250 18-22/ VN  
ROCKETMAN SPORT-250  
20-22/ VN ROCKETMAN  
CARRERA-250 22/ VN  
SCREAMER-250 21/ VN  
STORM-250 21-22/ VN  
THUNDERSTAR-250 20-22/  
VN TORNADO-250 21-22



### EJE-008

EJE PEDAL DE  
ARRANQUE-(classic)

IT DT-90 17 / IT STRADA-70  
05-08 /IT ST-90 09-18



### EJE-133

EJE PEDAL  
DEARRANQUE-(classic)

VN CYCLONE-150 21-22/  
VN FALKON-250 22/ VN  
LITHIUM2.0-150 20-21/  
VN RYDER3.0-150 20-22/  
VN URBAN3.0-150 19-22/  
VN WORKMAN-150 20-  
22/ VN XPRESS-150 16-22/  
VN CROSSMAX PLUS-250  
20-22/ VN CROSSMAX PRO



### PIÑ-013

ENGRANE PIÑON 14T  
DIENTES-(Gold)

BJ NS-200



### PIÑ-004

ENGRANE PIÑON 14T  
DIENTES-(classic)

HO CARGO-125 /IT AT-110  
SPORT



### ECD-004

ENGRANE DE CADENA DE  
DISTRIBUCION-(Gold)

IT 125-FL 19-22



### PIÑ-003

ENGRANE PIÑON 15T  
DIENTES-(Gold)

IT 125-Z/IT DM-125 /IT  
DM-200 14-17 /IT DT-125  
CLASICA 17 /IT DT-125  
DELIVERY 17 /IT DT-125  
SPORT 17 /IT DT-150 SP



Linea de Motor

MOTOR LINE

LESSIA  
Motorcycle Products

#SomosPartedeTuMoto

LESSIA  
Motorcycle Products



### PIÑ-011

#### ENGRANE PIÑON 13T DIENTES-(Gold)

IT 250-SZ 23/IT 250-Z 14-17/  
IT 250-Z NE 17-19/IT DM-150  
10-23/IT DM-150RO 18-21



### ECD-003

#### ENGRANE DE CADENA DE DISTRIBUCIÓN-(Gold)

IT 250-Z 14-17 /IT 250-Z  
NEGRA 17 /IT DM-250  
16 /IT RT-250 16-17/TK  
TEKKEN-250 16/ MB  
BERETTA 250 17-21



### PIÑ-010

#### ENGRANE PIÑON 12T DIENTES-(Gold)

IT 250Z 15/IT TC-200 14-16/  
IT TC-200BL 16-18/IT TC-  
200NE 18-20/IT TC-250  
16-22



### ECD-005

#### ENGRANE DE CADENA DE DISTRIBUCIÓN

IT AT-110RO 17-20/IT AX-110  
16/IT AR-110 15/IT AT-110 14-  
22



### ECD-002

#### ENGRANE DE CADENA DE DISTRIBUCION-(Gold)

IT AR-110 15 / IT AT-110  
14-16 /IT AT-110 SPORT  
11-15 /IT AT-125 17-18 /IT  
ARGENTA-110 05-13 / GT-110  
ALESSIA 16



### EBO-001

#### ENGRANE DE BOMBA DE ACEITE-(Gold)

IT AR-110 15 /IT AT-110 14-16 /  
IT AT-110 NEGRA 16-18 /IT  
AT-110 ROJA 17-18 /IT AT-110  
RT 12-14 /IT AT-110 RT 12-14



### PIÑ-005

#### ENGRANE PIÑON 17T DIENTES-(classic)

IT ATV-150 SPORT C/  
REVERSA



### PIÑ-002

#### ENGRANE PIÑON 21T DIENTES-(classic)

IT ATV-180 16-20



Linea de Motor

MOTOR LINE

LESSIA  
Motorcycle Products

#SomosPartedeTuMoto

LESSIA  
Motorcycle Products



### ENG-GYF-02

ENGRANE DE CIGÜEÑAL-  
(Gold)

IT CS-125 14-17 /IT CS-125  
LED 13-16 /IT D-125 16-17 /IT  
DS-125 17 /IT DS-150 14-17 /  
IT DS-150 NEGRO 13-15 /IT  
DSG-125 17-21



### PIÑ-017

ENGRANE PIÑON 14T  
DIENTES

IT DT-125 15-16/IT FT-180TS  
2023/IT RC-200 19-24/IT  
FT-150G 22-23/IT SPTFIRE  
19-22/IT 170-Z 16-18/IT FT-  
150GTS 22-24/IT FT-200TS  
19-24/IT AT-125RT 20-24/IT  
SPTFIRE-250 23-24/IT 150-  
SZ 16-18/IT 150-Z 1



### PIÑ-008

ENGRANE PIÑON 14T  
DIENTES-(Gold)

IT FT-150 HD 20-21/ IT V-200  
18-20



### ENG-024

ENGRANE DEL  
BALANCEADO-(Gold)

IT FT-180 13-18 /IT RT-180 11-  
13/DI RAYO-250 18-20



### PIÑ-012

ENGRANE PIÑON 17T  
DIENTES-(Gold)

IT NXR-125



### PIÑ-009

ENGRANE PIÑON 14T  
DIENTES-(Gold)

IT NXR-125



### PIÑ-007

ENGRANE PIÑON 14T  
DIENTES-(Gold)

IT VORT-X 300 17-22/IT  
VORT-X 300R 21-22



### PIÑ-006

ENGRANE PIÑON 13T  
DIENTES-(Gold)

IT VORT-X200 18-22/IT DM-  
250 16-18/IT RT-200 16-20/  
IT RT-250SP 20-22/IT 250-Z  
19-23



Linea de Motor

MOTOR LINE

LESSIA  
Motorcycle Products

#SomosPartedeTuMoto

LESSIA<sup>®</sup>  
Motorcycle Products



### PIÑ-018

#### ENGRANE PIÑON 14T

IT RC-200 19-24/IT SPTFIRE  
19-22/IT SPTFIRE-250 23-24/  
IT RC-150 16-24/IT RC-250  
24/IT 150-Z 14-24/IT 200-Z  
19-24



### ENG-025

#### ENGRANE IMPULSOR CLASSIC

MOTOS DE TRABAJO



### PIÑ-016

#### ENGRANE PIÑON 16T DIENTES

VC XEVERUS-250



### PIÑ-015

#### ENGRANE PIÑON 15T DIENTES-(Gold)

VN NITROX-250 T2 20-22/  
VN NITROX-200 20-22



### PIÑ-014

#### ENGRANE PIÑON 14T DIENTES-(Gold)

YA FZ-16

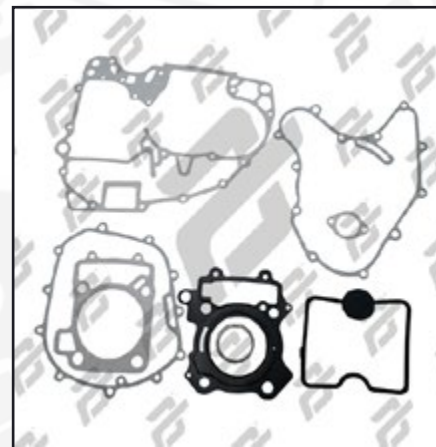

### EMP-050

#### EMPAQUE DE MOTOR- (classic)

BJ PULSAR NS-200

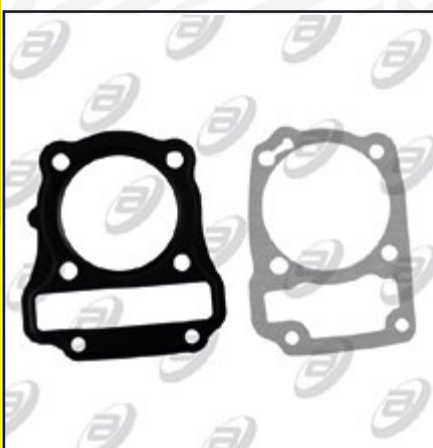

### EMC-034

#### EMPAQUE DE CILINDRO- (classic)

IT 125-FL 19-20 /IT 125-FL  
PAR LAR 19-20

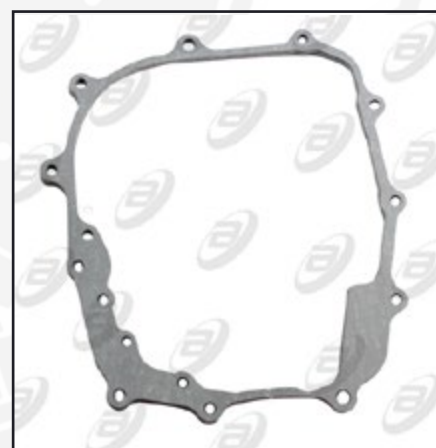

### EMP-A005

#### EMPAQUE LATERAL DERECHO-(classic)

IT 125-FL 19-20 /IT 125-FL  
PAR LAR 19-20



Linea de Motor

MOTOR LINE

LESSIA  
Motorcycle Products

#SomosPartedeTuMoto

LESSIA  
Motorcycle Products



### EMP-A007

#### EMPAQUE DE CAJA DE VELOCIDADES-(classic)

IT 125-Z 16-20 /IT 125-SZ 16-18 /IT 150-SZ 16-18 /IT 150-Z 14-20 /IT DM-150 RO 18-20 /IT DT-150 CL 17-18 /IT DT-150

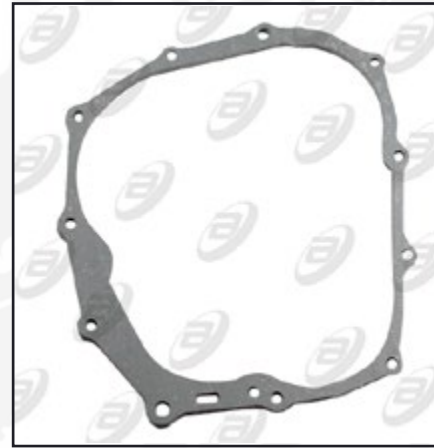

### EMP-A006

#### EMPAQUE LATERAL DERECHO-(classic)

IT 125-Z 16-20 /IT 150-SZ 16-18 /IT 150-Z 14-20 /IT DM-150 RO 18-20 /IT DT-150 CLA 17-18 /IT DT-150 DEL 17-18



### EMP-A009

#### EMPAQUE DE CAJA DE VELOCIDADES-(classic)

IT 250-Z 14-17 /IT 250-Z NE 17-19 /IT RC-150 09-17 /IT RC-150 GT 12-15 /IT RC-200 19-20 /IT RT-200 09-16 /IT RT-200 09-16



### EMC-042

#### EMPAQUES DE CABEZA

IT ATV-200 20-24



### COP-A003

#### BAQUELITA DE COPLER DE CARBURADOR-(classic)

IT ATV-150 05-11 /IT CS-125 14-17 /IT CS-125 LED 13-16 /IT D-125 16-17 /IT DS-125 17 /IT DS-150 14-17 /IT DS-150 NEGRO 13-15 /VN ATOM-150 14-18



### EMP-A003

#### EMPAQUE LATERAL IZQUIERDO-(classic)

IT CS-125 14-18 /IT CS-125 LED 13-20 /IT D150 19-20 /IT DS-125 17-20 /IT DSG-125 17-19 /IT CITY 125 05-13 /IT VGO 125 15-17

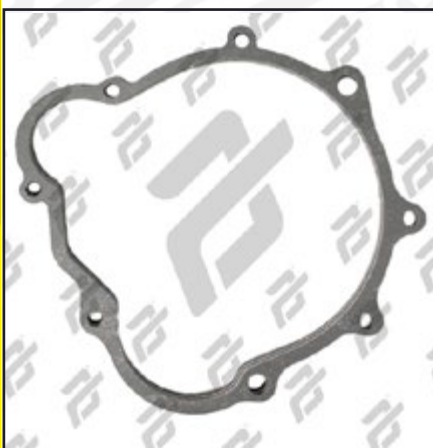

### EMP-A022

#### EMPAQUE LATERAL IZQUIERDO ESTATOR-(Gold)

IT DM-125 17-21 /IT DM-150SP 19-21 /IT DM-200 14-21 /IT DM-200SP 19-21 /IT DM-250 20-21

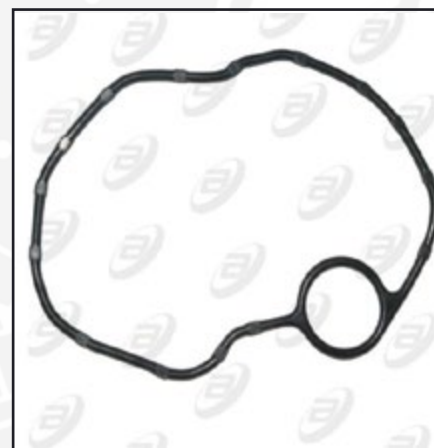

### EMP-A020

#### EMPAQUE DE CUBIERTA DE CABEZA LIGA-(Gold)

IT DM-200 14-17



Linea de Motor

MOTOR LINE

LESSIA  
Motorcycle Products

#SomosPartedeTuMoto

LESSIA<sup>®</sup>  
Motorcycle Products

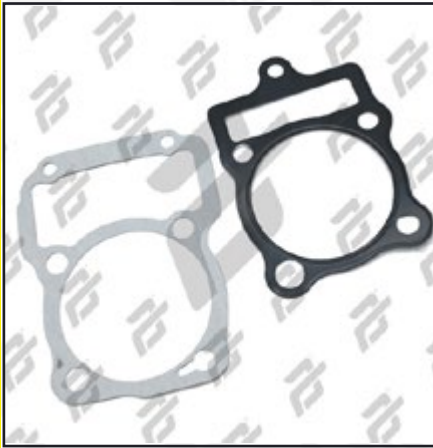

### EMC-040

EMPAQUES DE CABEZA-  
(Gold)

IT DM-250X 22-24/IT DM-  
250 20-24



### EMP-A019

EMPAQUE DE CUBIERTA  
DE CABEZA LIGA-(classic)

IT DS-150 09-20/VN ATOM-  
150 14-18



### EMP-A016

EMPAQUE LATERAL  
IZQUIERDO-(classic)

IT DS-150 14-20 /IT DS-150  
G 18-19 /IT DS-125 05-09 /IT  
DS-150 06-16 /IT DS-150 NE  
13-15 /IT GS-150 LED ELITE  
15-17



### EMC-039

EMPAQUES DE CABEZA  
(ALESSIA CLASIC )

IT SPTFIRE-250 23

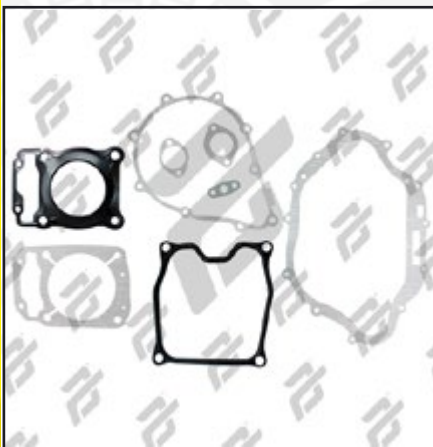

### EMP-044

EMPAQUES DE MOTOR-  
(classic)

IT V-200 18-21

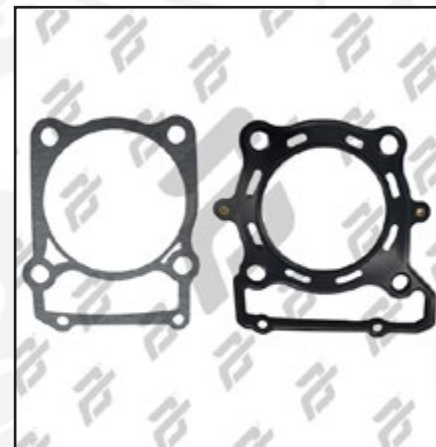

### EMC-041

EMPAQUES DE CABEZA  
(ALESSIA CLASIC )

IT VORT-X300 17-24/IT  
VORT-X300R 21-24

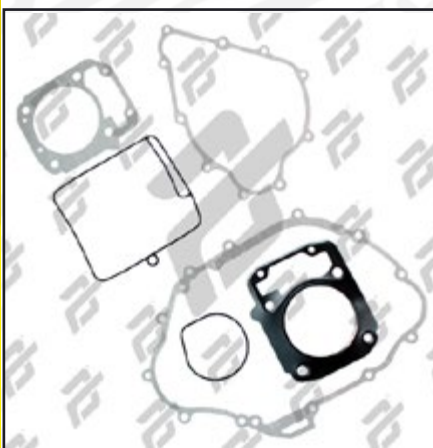

### EMP-045

EMPAQUES DE MOTOR-  
(classic)

IT VORTX-200 18-20

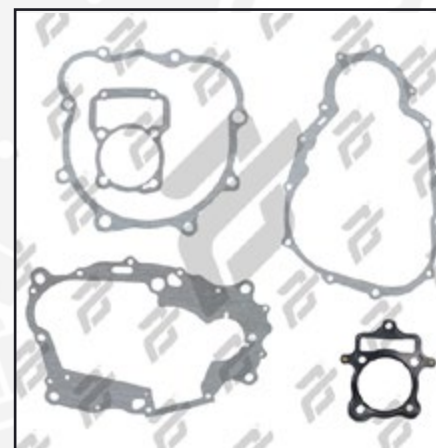

### EMP-051

EMPAQUE DE MOTOR-  
(Classic)

VE XEVERUS-250



Linea de Motor

MOTOR LINE

LESSIA  
Motorcycle Products

#SomosPartedeTuMoto

LESSIA  
Motorcycle Products



### EMP-052

#### EMPAQUES DE MOTOR

VN RYDER 3.0 20-22/VN  
LITHIUM 2.0 20-21/VN  
XPRESS-150 16-23



### EMP-049

#### EMPAQUES DE MOTOR- (classic)

VN CROSSMAX-250 20-22/  
VN CROSSMAX PRO-250  
21-22/VN FALKON-250  
22/VN ROCKETMAN-250  
18-22/VN ROCKETMAN-  
250SP 20-22/VN  
ROCKETMAN-250CA 22/  
VN SCREAMER-250 21/  
VN STORM-250 21-22/VN



### EMC-038

#### EMPAQUES DE CABEZA- (classic)

VN CROSSMAX-250 20-22/  
VN CROSSMAX-250PRO 21-  
22/VN FALKON-250 22/VN  
ROCKETMAN-250 18-22/VN  
ROCKETMAN-250SP 20-22/  
VN ROCKETMAN-250CA  
22/VN SCREAMER-250 21/  
VN STORM-250 21-22/VN  
THUNDERSTAR-250 20-22/



### EMC-030

#### EMPAQUES DE CABEZA- (Rudos Biker)

BJ BOXER-150



### EMC-026

#### EMPAQUES DE CABEZA- (Rudos Biker)

HO CARGO-150



### EMC-027

#### EMPAQUES DE CABEZA- (classic)

IT 170-Z



### EMC-023

#### EMPAQUES DE CABEZA- (classic)

IT 250S-Z 15 /IT FT-250 15-16  
/IT FT-250 TS 16-17 /IT TC-  
250 15-16 /IT 250-Z 14-17/IT  
250-Z NEGRA 17 /IT DM-250  
16



### EMC-022

#### EMPAQUES DE CABEZA- (classic)

IT AT-110 10-17 / KU GALAXY  
05-14



Linea de Motor

MOTOR LINE

LESSIA  
Motorcycle Products

#SomosPartedeTuMoto

LESSIA<sup>®</sup>  
Motorcycle Products



### EMC-017

EMPAQUES DE CABEZA-  
(classic)

IT AT-110 RT LED 14-16 /IT  
AT-110RT 12-14 /IT AT-110RT  
CON LED 16-17 /IT X-110 17 /  
IT XT-110RT II 177 /IT XT-110  
11-15



### EMC-033

EMPAQUES DE CABEZA-  
(classic)

IT AT-125 17-19



### EMC-024

EMPAQUES DE CABEZA-  
(classic)

IT ATV-180



### EMC-002

EMPAQUES DE CABEZA-  
(classic)

IT CS-125 14-18 /IT CS-125  
LED 13-16 /IT D-125 16-18 /  
IT DS-125 17-18 /IT DSG-125  
17-18 /IT CITY-125 05-13 /IT  
DS-125 17-20



### EMC-032

EMPAQUES DE CABEZA-  
(classic)

IT DM-125 17-19

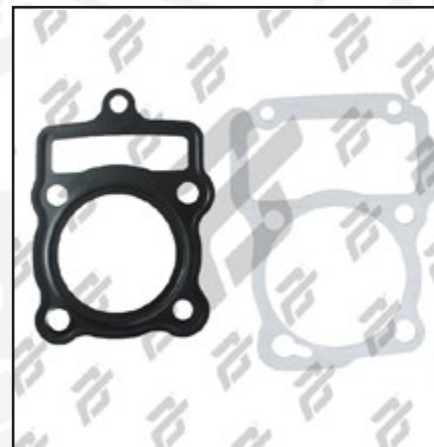

### EMC-036

EMPAQUES DE CABEZA-  
(classic)

IT DM-125 17-21



### EMC-015

EMPAQUES DE CABEZA-  
(classic)

IT DM-150 /IT 150-Z /IT RC-  
150 /IT RC-150GT

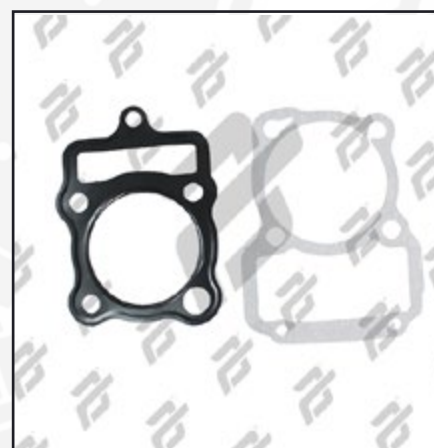

### EMC-035

EMPAQUES DE CABEZA-  
(classic)

IT DM-150SP 19-21



Linea de Motor

MOTOR LINE

LESSIA  
Motorcycle Products

#SomosPartedeTuMoto

LESSIA  
Motorcycle Products



### EMC-019

#### EMPAQUES DE CABEZA- (classic)

IT DM-200 07-18 /IT DT-200  
SPORT 17 /IT FT-200 14-15 /  
IT FT-200 AMARILLA 15/IT  
RC-200 09 /IT TC-200 14-18



### EMC-003

#### EMPAQUES DE CABEZA- (classic)

IT DS-150 14-18 / IT DS-150G  
18 /IT DS-150 VERDE 18 /IT  
DS-150 NEGRO 13-15 /IT DS-  
150 05-16 /IT GS-150 10-13 /IT  
GS 150 10-13/VN ATOM-150  
14-18



### EMC-029

#### EMPAQUES DE CABEZA- (classic)

IT DT-110 DELIVERY 16-18 /IT  
FT-115 16-18



### EMC-021

#### EMPAQUES DE CABEZA- (classic)

IT FT-125 JGO /KU  
CLASSIC-125



### EMC-005

#### EMPAQUES DE CABEZA- (classic)

IT FT-150 / KU DELIVERY  
MAX-150



### EMC-020

#### EMPAQUES DE CABEZA- (classic)

IT FT-180 13-18 /IT RT-180  
11-13



### EMC-008

#### EMPAQUES DE CABEZA- (classic)

IT GSC-175 15-18 /IT GTS-175  
10-14 /IT GTS-175 CON LEDS  
13-15 /IT GTS-175 LED CAJA  
14-15 /IT MODENA-175 18-21



### EMC-037

#### EMPAQUES DE CABEZA- (classic)

IT V-200 18-21



Linea de Motor

MOTOR LINE

LESSIA  
Motorcycle Products

#SomosPartedeTuMoto

LESSIA<sup>®</sup>  
Motorcycle Products



### EMC-028

EMPAQUES DE CABEZA-  
(Rudos Biker)

IT V-200 18-21



### EMC-012

EMPAQUES DE CABEZA-  
(classic)

SK EN-125



### EMC-013

EMPAQUES DE CABEZA-  
(classic)

YA BWS-100



### EMC-011

EMPAQUES DE CABEZA-  
(classic)

YA YBR-125



### EMP-031

EMPAQUES DE MOTOR-  
(Rudos Biker)

BJ BOXER-150

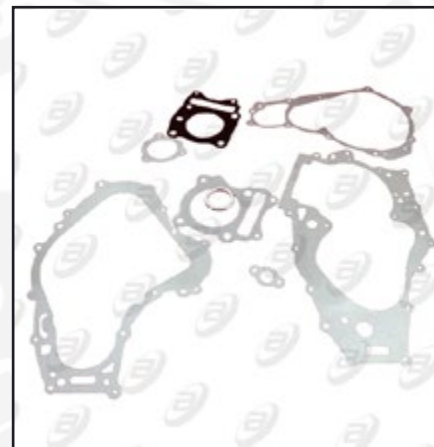

### EMP-034

EMPAQUES DE MOTOR-  
(classic)

BJ MOTOCARRO 200cc  
KING



### EMP-013

EMPAQUES DE MOTOR-  
(classic)

HO CARGO-125 06-10



### EMP-032

EMPAQUES DE MOTOR-  
(Rudos Biker)

HO CARGO-150



Linea de Motor

MOTOR LINE

LESSIA  
Motorcycle Products

#SomosPartedeTuMoto

LESSIA  
Motorcycle Products



### EMP-029

EMPAQUES DE MOTOR-  
(Rudos Biker)

HO CGL-125 TOOL

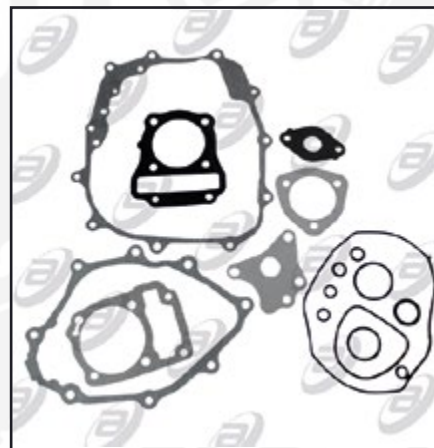

### EMP-042

EMPAQUES DE MOTOR-  
(classic)

IT 125-FL 19-20 /IT 125-FL  
PAR LAR 19-20



### EMP-023

EMPAQUES DE MOTOR-  
(classic)

IT 150-Z/DI US-150 /CAFE  
RACER-150



### EMP-030

EMPAQUES DE MOTOR-  
(classic)

IT 170-Z 16-18



### EMP-028

EMPAQUES DE MOTOR-  
(Gold)

IT 250-Z 14-17 /IT 250-Z  
NEGRA 17 /IT 250S-Z 15 /IT  
FT-250 15-16/IT FT-250 TS  
16-17 /IT TC-250 15-167 /IT  
TC-250 15



### EMP-SAE-04

EMPAQUES DE MOTOR-  
(Gold)

IT A-110 15 /IT AT-110 14-16 /IT  
AT-110 NEGRA 16-17 /IT AT-  
110 RT 12-14/IT AT-110RTLED  
14-16 /IT AT-110RT CON LED  
16-21



### EMP-021

EMPAQUES DE MOTOR-  
(Gold)

IT AT-110 RT LED 14-16 /IT  
AT-110RT 12-14 /IT AT-110RT  
CON LED 16-17 /IT X-110 17/IT  
XT-110RT-17

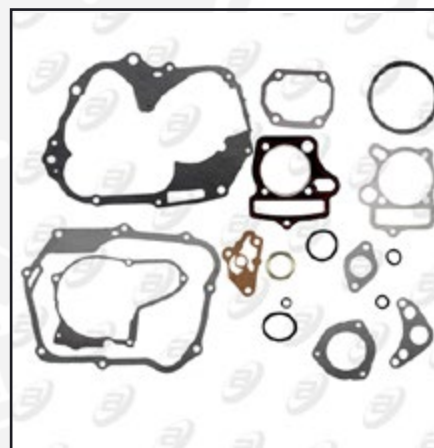

### EMP-038

EMPAQUES DE MOTOR-  
(classic)

IT AT-125 17-19/DI  
MONKEY-125 20-21



Linea de Motor

MOTOR LINE

LESSIA  
Motorcycle Products

#SomosPartedeTuMoto

LESSIA  
Motorcycle Products



### EMP-GYG-04

EMPAQUES DE MOTOR-  
(Gold)

IT ATV-150 05-07 /IT DS-150  
14-17 / IT DS-150 NEGRO 13-  
15 /IT DIABOLO-150 06-13 /  
IT GS-150 10-13 /IT GS-150  
CON LED 13-15

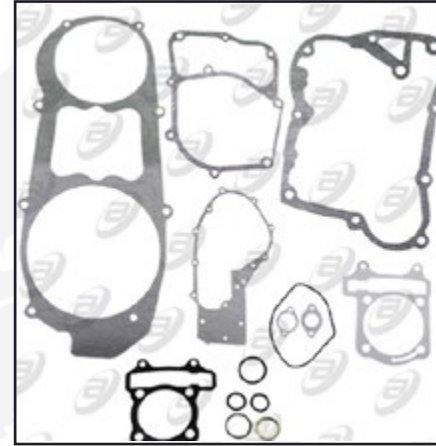

### EMP-039

EMPAQUES DE MOTOR-  
(classic)

IT ATV-180



### EMP-040

EMPAQUES DE MOTOR-  
(classic)

IT ATV-250 C/REVERSA



### EMP-GYF-02

EMPAQUES DE MOTOR-  
(Gold)

IT CS-125 14-17 /IT CS-125  
LED 13-16 /IT D-125 16-17 /IT  
DS-125 17 /IT DIABOLO 125  
05-09 /IT VGO-125 15-16 /IT  
VITALIA-125 14-19



### EMP-037

EMPAQUES DE MOTOR-  
(classic)

IT DM-125 17-19

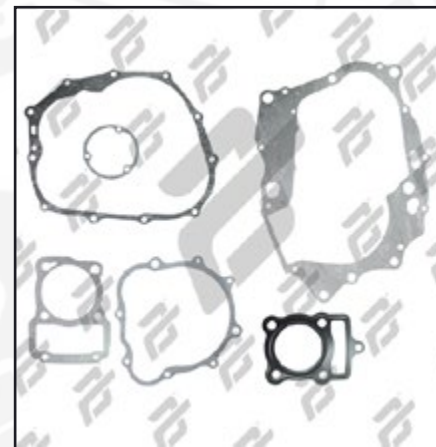

### EMP-048

EMPAQUES DE MOTOR-  
(classic)

IT DM-125 17-21



### EMP-043

EMPAQUES DE MOTOR-  
(classic)

IT DM-150 SP 19-21

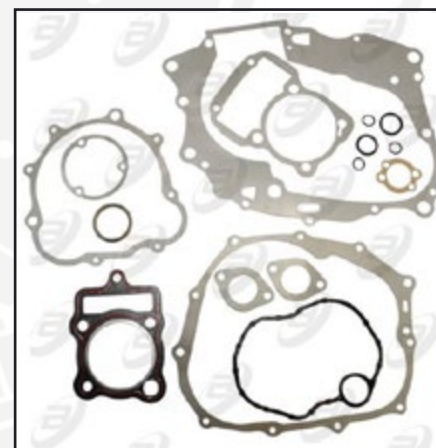

### EMP-019

EMPAQUES DE MOTOR-  
(Gold)

IT DM-150/BM FORZZA-300  
19-21/VN TERRA-150 15-17/  
MB GAMMA GT-150 18-20



Linea de Motor

MOTOR LINE

LESSIA  
Motorcycle Products

#SomosPartedeTuMoto

LESSIA  
Motorcycle Products



### EMP-020

#### EMPAQUES DE MOTOR- (classic)

IT DM-200 14-17 / RISKY-200  
16/TK TEKKEN-250 16/  
MB BERETTA 250 17-21/  
MB XROAD GT-200 19/MB  
XTRAIL 250 17-21



### EMP-033

#### EMPAQUES DE MOTOR- (classic)

IT DT-110 DELIVERY 16-18 /IT  
FT-115 16-18



### EMP-CGF-01

#### EMPAQUES DE MOTOR- (Gold)

IT DT-125 12-16 /IT DT-125  
CLASICA 17 /IT DT-125  
DELIVERY 17 /IT DT-125  
SPORT 17 /IT FORZA 125 05-  
12 /IT FT-125 CL 12-16

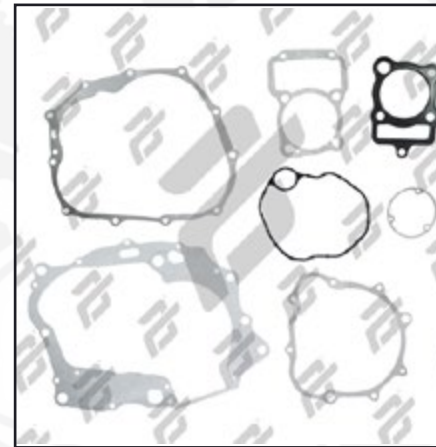

### EMP-046

#### EMPAQUES DE MOTOR- (classic)

IT DT-150SP 20-21/IT DT-  
150SP II 17-20/IT FIERA-150  
18-19



### EMP-025

#### EMPAQUES DE MOTOR- (classic)

IT DT-200 SPORT 17-18 /  
IT FIERA-200 18 /IT FT-200  
14-15 /IT FT-200 AMARILLA  
15-17 /IT TC-200 14-16 /IT TC-  
200 BL 16-18



### EMP-CGG-01

#### EMPAQUES DE MOTOR- (Gold)

IT FORZA-150/ IT FT-150 / KU  
DELIVERY MAX-150 06-13



### EMP-005

#### EMPAQUES DE MOTOR- (Gold)

IT FT-110 10-14



### EMP-026

#### EMPAQUES DE MOTOR- (classic)

IT FT-180 13-17 /IT RT-180  
11-13/DI RAYO 175



Linea de Motor

MOTOR LINE

LESSIA  
Motorcycle Products

#SomosPartedeTuMoto

LESSIA  
Motorcycle Products



### EMP-022

EMPAQUES DE MOTOR-  
(classic)

IT RC-150

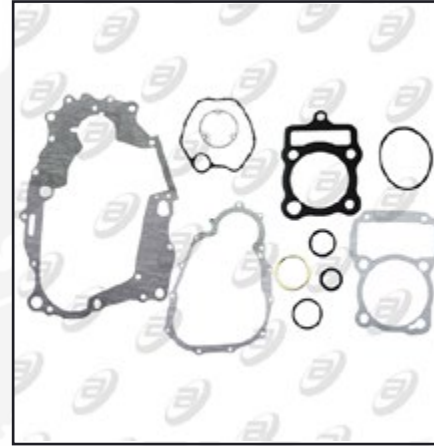

### EMP-041

EMPAQUES DE MOTOR-  
(classic)

IT RT-200



### EMP-024

EMPAQUES DE MOTOR-  
(classic)

IT TC-200/IT RC -200/IT TC-  
250/CA C-200 / CA BG-200  
BENGALA



### EMP-027

EMPAQUES DE MOTOR-  
(Gold)

SK EN-125



### EMP-017

EMPAQUES DE MOTOR-  
(Gold)

YA BWS-100



### EMP-001

EMPAQUES DE MOTOR-  
(Rudos Biker)

YA FZ-16



### EMP-014

EMPAQUES DE MOTOR-  
(Gold)

YA YBR-125



### ESR-002

ESTRELLA DE CAMBIOS  
GUIA Y RESORTE-(classic)

IT 125-FL 19-20 /IT 125-FL  
PARRILLA LARGA 19-20



Linea de Motor

MOTOR LINE

LESSIA  
Motorcycle Products

#SomosPartedeTuMoto

LESSIA  
Motorcycle Products



### ESR-CGM-01

ESTRELLA DE CAMBIOS  
GUIA Y RESORTE-(classic)

VN NITROX-250 T3 22-24/  
IT 125-Z 16-20/IT 150-SZ 16-  
18/IT 150-Z 14-20/IT 250-Z  
14-17/IT 250-Z NE 17-19/IT  
DM-125 17-20/IT DM-150 SP  
19-21/IT DM-150 RO 18-20/  
IT DM-200 14-20/IT DM-200  
SP 19-20/IT DM-250 20/IT  
DT-125 CL 17-19/IT DT-125



### ESR-SAE-01

ESTRELLA DE CAMBIOS  
GUIA Y RESORTE-(classic)

IT AT-110 SPORT/IT AT-110  
/ KU GALAXY- 125/GT-110  
ALESSIA



### ESR-CGG-02

ESTRELLA DE CAMBIOS  
GUIA Y RESORTE-(classic)

IT DM-150 10-19/IT DT-150  
SPORT 17-18/IT FORZA-150  
06-13/IT FT-150 14-16/IT FT-  
150 AZP 13-16/IT FT-150 G  
16-18/IT FT-150 G NE 18-20/IT  
FT-150 GT 11-13/IT FT-150 GT  
GO 13-14/IT FT-150GT115-17/  
IT FT-150 GTS 16-18/IT FT-  
150 GTS RO 18-20



### ESR-004

ESTRELLA DE  
CAMBIOS,GUIA Y  
RESORTE-(classic)

IT DM-250 16-21/IT RT-250  
16-21/IT 250-Z 19-21



### FIL-027

FILTRO DE ACEITE-(Rudos  
Biker)

BJ BOXER-150/ FZ-16



### FIL-028

FILTRO DE ACEITE-(Rudos  
Biker)

BJ NS-200 / KTM DUKE-250  
18/BJ DOMINAR-400 19-21/  
BJ RS-200 17-20/BJ AS-200  
17-20



### FIL-039

FILTRO DE ACEITE  
(RUDOS BIKER)

BMW G-310



### FIL-029

FILTRO DE ACEITE-(Rudos  
Biker)

HO CARGO-150



Linea de Motor

MOTOR LINE

LESSIA  
Motorcycle Products

#SomosPartedeTuMoto

LESSIA  
Motorcycle Products



### FIL-033

FILTRO DE ACEITE-(Rudos Biker)

HO CBR-600



### FIL-024

FILTRO DE ACEITE METALICO-(Rudos Biker)

HO CGL-125 TOOL



### FIL-CGM-01

FILTRO DE ACEITE-(classic)

IT 125-Z 16-17 /IT 150SZ 16-18 /IT 150-Z 14-16 /IT 170-Z 16-18 /IT 250-Z 14-17 /IT 250-Z NEGRA 17-19 /IT DM-150 10-19/VN CROSS MAX-200 19-21/VN LITHIUM-150 2.0 17-21



### FIL-016

FILTRO DE ACEITE-(classic)

IT DM-200/VN RYDER5.0-190 23-24



### FIL-011

FILTRO DE ACEITE-(classic)

IT DS-150 / IZ SL-125 Y 150



### FIL-036

FILTRO DE ACEITE-(Rudos Biker)

IT TC-200 14-16/IT TC-200BL 16-18/IT TC-200NE 18-20/IT TC-250 15-20



### FIL-037

FILTRO DE ACEITE-(classic)

IT V-200 18-23 / YA FZ-2.0 / YA YZ-250F / YA YZ-450F



### FIL-038

FILTRO DE ACEITE (CLASSIC)

IT VORT-X300 17-24/IT VORT-X300R 21-24



Linea de Motor

MOTOR LINE

LESSIA  
Motorcycle Products

#SomosPartedeTuMoto

LESSIA  
Motorcycle Products



### FIL-041

#### FILTRO DE ACEITE

IT VORT-X 250 22-24 / IT  
BLACKBIRD 21-24



### FIL-032

#### FILTRO DE ACEITE-(Rudos Biker)

SK EN-125/SK GN-125 17-20/  
SK GIXXER-150 17-20/SK  
GSX-150 18-20/ITVORT-X  
200 18-22



### FIL-040

#### FILTRO DE ACEITE (RUDOS BIKER)

YA YZ-250F/ YA YZ-450F



### FIL-004

#### FILTRO DE ACEITE- (classic)

YA FZ-16 12-13



### FIL-035

#### FILTRO DE ACEITE- (classic)

YA VIRAGO-250



### FIL-025

#### FILTRO DE ACEITE MALLA-(Rudos Biker)

YA YBR-125

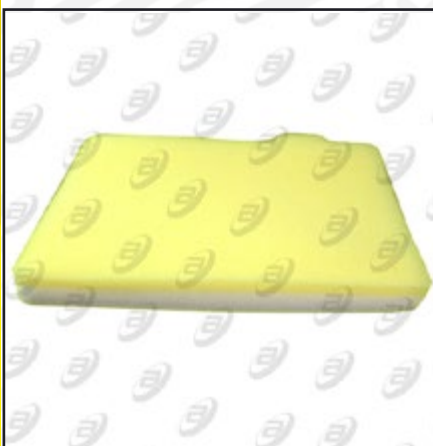

### FIA-051

#### FILTRO DE AIRE ELEMENTO-(Rudos Biker)

BJ BOXER 150 / BJ PULSAR  
135/BJ BOXER 100 14-17



### FIA-066

#### FILTRO DE AIRE ELEMENTO-(Rudos Biker)

BJ NS-200



Linea de Motor

MOTOR LINE

LESSIA  
Motorcycle Products

#SomosPartedeTuMoto

LESSIA  
Motorcycle Products



**FIA-050**

FILTRO DE AIRE  
ELEMENTO-(Rudos Biker)

BJ RS-200/BJ  
DOMINAR-400 19-21



**FIA-093**

FILTRO DE AIRE  
ELEMENTO

HE HUNK-150



**FIA-091**

FILTRO DE AIRE  
ELEMENTO

HO CB-160 / HO CB-190R



**FIA-073**

FILTRO DE AIRE  
ELEMENTO-(classic)

HO CARGO-125 2008 /HO  
TITAN 125 2000 2008



**FIA-064**

FILTRO DE AIRE  
ELEMENTO-(classic)

HO CG-150



**FIA-063**

FILTRO DE AIRE  
ELEMENTO-(classic)

HO CGL-125 TOOL



**FIA-019**

FILTRO DE AIRE  
ELEMENTO-(classic)

HO GL150 CARGO



**FIA-069**

FILTRO DE AIRE  
ELEMENTO-(Rudos Biker)

HO XR-150L



Linea de Motor

MOTOR LINE

LESSIA  
Motorcycle Products

#SomosPartedeTuMoto

LESSIA  
Motorcycle Products



### FIA-043

#### FILTRO DE AIRE ELEMENTO-(classic)

IT 125-Z 16-17 /IT DT-125  
CLASICA 17 /IT DT-125  
DELIVERY 17 /IT DT-  
125 SPORT 17 /IT DT-150  
CLASICA 17 /IT DT-150 20-21



### FIA-A008

#### FILTRO DE AIRE COMPLETO-(classic)

IT 125-Z 16-17 /IT DT-125  
CLASICA 17-19 /IT DT-125  
DELIVERY 17-21 /IT DT-125  
SPORT 17-21 /IT DT-150  
CLASICA 1721 /IT DT-150  
20-21



### FIA-026

#### FILTRO DE AIRE ELEMENTO-(classic)

IT 150-Z /IT 150-SZ /IT 170-Z/  
IT 170-Z NEGRA /IT 250-Z  
14-17 /IT 250-Z NEGRA 17-18  
/IT TC-200 NEGRA 18-19



### FIA-053

#### FILTRO DE AIRE ELEMENTO-(classic)

IT 250-SZ 15 /IT DT-125  
12-16 /IT RC-150 16-19/  
IT SPTFIRE-200 19-21/  
IT FORZA-300 20-21/MB  
KUPRA-250 16-19



### FIA-001

#### FILTRO DE AIRE ELEMENTO-(classic)

IT AR-110 15 /IT AT-110  
NEGRA 16-18 /IT AT-110 RT  
12-14 /IT AT-110RTLED 14-16 /  
IT AT-110RT CON LED 16-21 /  
IT AT-100 SPORT 11-15



### FIA-A007

#### FILTRO DE AIRE COMPLETO-(classic)

IT ARGENTA-110 /IT AT-110



### FIA-027

#### FILTRO DE AIRE ELEMENTO-(classic)

IT AT-110 RT 12-14 /IT AT-  
110RTLED 14-16 /IT AT-110RT  
CON LED 16-17



### FIA-054

#### FILTRO DE AIRE ELEMENTO-(Xtreme)

IT AT-125 17-19



Linea de Motor

MOTOR LINE

LESSIA  
Motorcycle Products

#SomosPartedeTuMoto

LESSIA  
Motorcycle Products



### FIA-014

#### FILTRO DE AIRE ELEMENTO-(classic)

IT ATV-150 SPORT 11-12 /  
IT ATV-150 SPORT C /  
REVERSA 12-17 /IT ATV-180  
16-17-17



### FIA-055

#### FILTRO DE AIRE ELEMENTO-(classic)

IT ATV-250 C/REVERSA 14-  
18 /IT ATV-250 NEGRA 18-19



### FIA-NO073

#### FILTRO DE AIRE ELEMENTO Triangular- (classic)

IT CS-125 14-17 /IT CS-125  
LED 13-16 /IT DS-125 17 /  
IT DSG-125 17 / IT CITY-125  
05-13 /IT VGO-125 15-16 / IT  
VITALIA 125 15-19/IT VITALIA  
150 16-18



### FIA-074

#### FILTRO DE AIRE ELEMENTO-(classic)

IT D-125 16-18 /IT X-125 18



### FIA-075

#### FILTRO DE AIRE ELEMENTO-(classic)

IT D-150 19-21/IT X-150D  
19-20



### FIA-049

#### FILTRO DE AIRE ELEMENTO-(classic)

IT DM-125 17-19



### FIA-072

#### FILTRO DE AIRE ELEMENTO-(classic)

IT DM-150 10-17



### FIA-SHT15

#### FILTRO DE AIRE ELEMENTO REDONDO- (classic)

IT DS-150 16-17 /IT DIABOLO  
125 05-09 /IT DIABOLO-150  
06-13 /IT GS-150 10-13 /IT  
GS-150 CON LEDS 13-15 /  
IT GS-15/VN PHANTOM-150  
15-17 /IZ SL-125 /IZSL-150 /IT  
VX-150



Linea de Motor

MOTOR LINE

LESSIA  
Motorcycle Products

#SomosPartedeTuMoto

LESSIA  
Motorcycle Products



### FIA-056

FILTRO DE AIRE  
ELEMENTO-(Xtreme)

IT DT-110 DELIVERY 16-19 /IT  
FT-115 16-19



### FIA-015

FILTRO DE AIRE  
ELEMENTO-(classic)

IT DT-150 SPORT 17-18 /IT  
FORZA 150 06-13 /IT FT-150  
14-16 /IT FT-150 AZULP 13-16  
/IT FT-150G 16-18 /IT FT-150  
GT 11-13



### FIA-041

FILTRO DE AIRE  
ELEMENTO-(classic)

IT DT-200 SPORT 17 /IT FT-  
180 13-17 /IT FT-200 14-15 /IT  
FT-200 AMARILLA 15/IT FT-  
250 15-16 /IT FT-250 TS 16-17



### FIA-057

FILTRO DE AIRE  
ELEMENTO-(classic)

IT FIERA 200 18-19 /IT FIERA  
250 18-19



### FIA-058

FILTRO DE AIRE  
ELEMENTO-(Xtreme)

IT FT-180TS 19-23/IT FT-  
200TS 19-23/IT RT-200 09-  
13/IT RT-200 NEGRO 13-15/IT  
DT-150 SP 20-23



### FIA-008

FILTRO DE AIRE  
ELEMENTO-(classic)

IT GSC-175 15-17 /IT TRN-150  
15-17 /IT TRN-175 16 /IT WS-  
175 15-16



### FIA-067

FILTRO DE AIRE  
ELEMENTO-(classic)

IT RC-150 09-17 /IT RC-150  
GT 12-15



### FIA-059

FILTRO DE AIRE  
ELEMENTO-(classic)

IT RT-200 15-16 /IT RT-250GP  
17-19



Linea de Motor

MOTOR LINE

LESSIA  
Motorcycle Products

#SomosPartedeTuMoto

LESSIA<sup>®</sup>  
Motorcycle Products



**FIA-060**

FILTRO DE AIRE  
ELEMENTO-(classic)

IT RT-250 16-19



**FIA-048**

FILTRO DE AIRE  
ELEMENTO-(classic)

IT TERRA X-150 / X5-150



**FIA-076**

FILTRO DE AIRE  
ELEMENTO-(classic)

IT V-200 18-22



**FIA-083**

FILTRO DE AIRE  
ELEMENTO-(Classic)

IT VITALIA-150 20-24



**FIA-079**

FILTRO DE AIRE  
ELEMENTO-(classic)

IT VORT-X 250 22

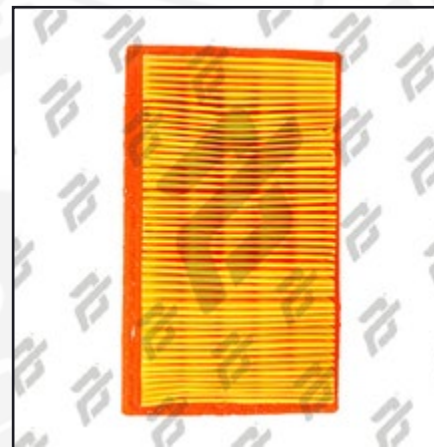

**FIA-071**

FILTRO DE AIRE  
ELEMENTO-(classic)

IT VORTX-200 18-22



**FIA-078**

FILTRO DE AIRE  
ELEMENTO-(classic)

IT VORTX-300 17-22/IT  
VORTX-300R 21-22



**FIA-077**

FILTRO DE AIRE  
ELEMENTO-(classic)

IT VX-250AD 16-18/IT VX-  
250EFI 19-21/IT VX-250 21-23



Linea de Motor

MOTOR LINE

LESSIA  
Motorcycle Products

#SomosPartedeTuMoto

LESSIA  
Motorcycle Products



**FIA-006**

**FILTRO DE AIRE  
ELEMENTO-(classic)**

IT W-150 17 /IT WS-150 08-17  
/ IT WS-150 NF 13-14



**FIA-062**

**FILTRO DE AIRE  
ELEMENTO-(classic)**

IT WS-150SP 17-24/ IT WS-  
175SP 18-24/ IT WS-175  
15-18/ IT DS-150G 19-23/ IT  
X-150G 22-23/ IT GSC-175 15-  
18/ IT MODENA-150 18-21/ IT  
MODENA-175 18-24/ IT TRN-  
150 15-20/ IT TRN-175 16



**FIA-085**

**FILTRO DE AIRE  
ELEMENTO**

SK GIXXER-150



**FIA-A001**

**FILTRO DE AIRE ALTO  
FLUJO 42mm-(Xtreme)**

MOTONETAS 125/150cc



**FIA-089**

**FILTRO DE AIRE  
ELEMENTO**

VN ROCKETMAN-250 18-22



**FIA-084**

**FILTRO DE AIRE  
ELEMENTO-(Classic)**

VN ATOM-150 19-24 / VN  
ATOM-170 22-24



**FIA-046**

**FILTRO DE AIRE  
ELEMENTO-(classic)**

VN CROSSMAX-250 PRO/  
DM-200 14-22/DM-150 22/  
DM-150RO 18-21/DM-150SP  
19-22/DM-200SP 19-22/  
DM-250 16-22/DM-250X 22/  
XEVERUS



**FIA-081**

**FILTRO DE AIRE  
ELEMENTO-(classic)**

VN LITHIUM4.0-150 20-22/  
RYDER3.0-150 20-22/VN  
WORKMAN-150 20-22/  
VN XPRESS-150 16-22/VN  
RYDER 5.0-190 23-24



Linea de Motor

MOTOR LINE

LESSIA  
Motorcycle Products

#SomosPartedeTuMoto

LESSIA  
Motorcycle Products



**FIA-080**

**FILTRO DE AIRE  
ELEMENTO-(classic)**

VN NITROX-250 T2 19-21/  
VN NITROX-200 19-21/VN  
NITROX-250 T3 22-24



**FIA-082**

**FILTRO DE AIRE  
ELEMENTO-(classic)**

VN SCREAMER-250 21/VN  
STORM-250 21-23



**FIA-070**

**FILTRO DE AIRE  
ELEMENTO-(Rudos Biker)**

VN OVNI-170 24 / HO DIO-  
110 / HO NAVI-110 / IT BIT-  
150 22-24



**FIA-087**

**FILTRO DE AIRE  
ELEMENTO-(classic)**

VN SPIRIT-170 23-24



**FIA-092**

**FILTRO DE AIRE  
ELEMENTO**

YA FZ-2.0



**FIA-086**

**FILTRO DE AIRE  
ELEMENTO**

YA YZF-R3 / YA MT-03



**FIA-065**

**FILTRO DE AIRE  
ELEMENTO-(classic)**

YA BWS-125



**FIA-007**

**FILTRO DE AIRE  
ELEMENTO-(classic)**

YA FZ-16 12-13



Linea de Motor

MOTOR LINE

LESSIA  
Motorcycle Products

#SomosPartedeTuMoto

LESSIA  
Motorcycle Products



### FIA-052

FILTRO DE AIRE  
ELEMENTO-(Rudos Biker)

YA FZ-16 20



### FIA-068

FILTRO DE AIRE  
ELEMENTO-(Rudos Biker)

YA RAY-Z



### FIA-A002

FILTRO DE AIRE  
COMPLETO-(classic)

YA YBR-125



### FIA-013

FILTRO DE AIRE  
ELEMENTO-(classic)

YA YBR-125 2008



### FIA-088

FILTRO DE AIRE  
ELEMENTO

KTM DUKE-200 12-21/  
KTM DUKE-250 14-16/KTM  
DUKE-390 14-16/KTM RC-  
200 14-21



### FIA-A014

FILTRO DE ALTO FLUJO-  
(Xtreme)

UNIVERSAL



### FIA-A014R

FILTRO DE ALTO FLUJO-  
(Xtreme)

UNIVERSAL ROJO 42mm



### FIA-A015AM

FILTRO DE ALTO FLUJO  
AMARILLO 35/42/48mm  
XTREME RACING

UNIVERSAL



Linea de Motor

MOTOR LINE

LESSIA  
Motorcycle Products

#SomosPartedeTuMoto

LESSIA  
Motorcycle Products



### FIA-A015PL

FILTRO DE ALTO FLUJO  
PLATA 35/42/48mm  
XTREME RACING

UNIVERSAL



### FIA-A015RJ

FILTRO DE ALTO FLUJO  
ROJO 35/42/48mm  
XTREME RACING

UNIVERSAL



### FIA-A016AM

FILTRO DE AIRE  
AMARILLO ALTO FLUJO  
CORTO 35/42/48mm

UNIVERSAL



### FIA-A016NJ

FILTRO DE AIRE NARANJA  
ALTO FLUJO CORTO  
35/42/48mm

UNIVERSAL



### FIA-A016PL

FILTRO DE AIRE PLATA  
ALTO FLUJO CORTO  
35/42/48mm

UNIVERSAL



### FIA-A016RJ

FILTRO DE AIRE ROJO  
ALTO FLUJO CORTO  
35/42/48mm

UNIVERSAL



### FIA-A016RS

FILTRO DE AIRE ROSA  
ALTO FLUJO CORTO  
35/42/48mm

UNIVERSAL



### FIA-A016VE

FILTRO DE AIRE VERDE  
ALTO FLUJO CORTO  
35/42/48mm

UNIVERSAL



Linea de Motor

MOTOR LINE

LESSIA  
Motorcycle Products

#SomosPartedeTuMoto

LESSIA  
Motorcycle Products



**FIA-A003**

FILTRO DE AIRE  
INDIVIDUAL 39mm-  
(Xtreme)

UNIVERSAL



**FIA-A004**

FILTRO DE AIRE  
INDIVIDUAL 48mm-  
(Xtreme)

UNIVERSAL



**FIA-A005**

FILTRO DE AIRE  
INDIVIDUAL 52mm-  
(Xtreme)

UNIVERSAL



**FIA-A006**

FILTRO DE AIRE  
INDIVIDUAL 54mm-  
(Xtreme)

UNIVERSAL



**FIA-A009**

FILTRO DE AIRE DE ALTO  
FLUJO 28 / 35 / 48mm  
VERDE-(Xtreme)

UNIVERSAL



**FIA-A010**

FILTRO DE AIRE DE ALTO  
FLUJO 28 / 35 / 48mm  
ROJO-(Xtreme)

UNIVERSAL



**FIA-A011**

FILTRO DE AIRE DE ALTO  
FLUJO 28 / 35 / 48mm  
NEGRO-(Xtreme)

UNIVERSAL



**FIA-A012**

FILTRO DE AIRE DE ALTO  
FLUJO 28 / 35 / 48mm  
PLATA-(Xtreme)

UNIVERSAL





**FIA-A013**

FILTRO DE AIRE DE ALTO  
FLUJO 28 / 35 / 48mm  
NARANJA-(Xtreme)

UNIVERSAL



**FIG-013**

FILTRO GASOLINA  
(RUDOS BIKER)

BJ PULSAR NS-200



**FIG-001**

FILTRO DE GASOLINA-  
(classic)

IT AR-110 /IT AT-110 /IT AT-110  
NEGRA /IT AT-110 SPORT /IT  
AX-110 /IT TORNADO-250 /  
IT RT-200 /IT RT-250 / IT XT-  
110 /IT 250-SZ 15 /IT ATV-150  
C/REVERSA 19 /IT ATV-150  
SPORT C/REVERSA 15-19 /  
IT AT-180 16-20 / IT DT-200  
SPORT 16-19 /IT FT-250 TS



**FIG-SH030**

FILTRO DE GASOLINA-  
(classic)

IT CS-125 14-17 /IT CS-125  
LED 13-16 /IT D-125 16-17 /IT  
DM-200 07-08 /IT DS-125 17  
/IT DS-150 14-17 /IT DS-150  
NE 13-15



**FIG-014**

FILTRO DE GASOLINA  
(RUDOS BIKER)

KTM DUKE-200 22-23/  
BJ PULSAR NS-200FI  
22-23/BJ RS-200 19-23/BJ  
DOMINAR-400UG 20-23/BJ  
DOMINAR-400TOURING  
20-23/KTM DUKE-390



**FIG-016**

FILTRO DE GASOLINA

UNIVERSAL



**FIG-002**

FILTRO DE GASOLINA  
PIEDRA-(classic)

UNIVERSAL



**FIG-007**

FILTRO GASOLINA  
TRANSPARENTE-(classic)

UNIVERSAL





**FIG-005**

**FILTRO DE GASOLINA  
ALUMINIO ROJO-(Xtreme)**

MOTONETAS CHINAS  
125CC Y 150CC 2005-2015



**FIG-011**

**FILTRO DE GASOLINA  
NEGRO-(Xtreme)**

UNIVERSAL



**ESC-C003**

**JUNTA DE ESCAPE-  
(classic)**

IT AR-110 /IT AT-110 NEGRA  
/IT AT-110SPORT /IT AX-110  
/IT EX-200 /IT RT-200 /IT  
RT-200 NEGRO /IT XT-110 /IT  
XT-110 GRAFITO 13-17



**ESC-C001**

**JUNTA DE ESCAPE-  
(classic)**

IT AT-110 RT 12-14/IT AT-  
110RT LED 14-16 /IT AT-110  
RT CON LED 16-17 /IT 125-Z  
16-17 /IT DT-150 CLASICA 17



**ESC-C010**

**JUNTA DE ESCAPE**

IT ATV-180 16-24/IT DM-  
200SP 19-21/IT ATV-150SP  
11-12/IT ATV-150SP C/REV  
12-19



**ESC-C006**

**JUNTA DE MOFLE Y  
BRAZO-(classic)**

IT DS-150



**ESC-C002**

**JUNTA DE ESCAPE-  
(classic)**

IT DS-150 14-17 / IT DS-150  
NEGRO 13-15 /IT DIABOLO  
125 05-09 /IT DIABOLO-150  
06-13 /IT GS-150 10-13 / IT  
ATV-150 06-11 /IT ATV-250 C/  
REVERSA 14-18 /IT ATV-250  
NEGRA 18-20 /IT ATV-150  
CON REVERSA 19 / IT ATV-  
150 SPORT C/REVERSA



**MNG-007**

**MANGUERA P MANIJA  
DE FRENO DELANTERO  
95cm-(classic)**

IT AT-110 TODOS LOS  
MODELOS



Linea de Motor

MOTOR LINE

LESSIA  
Motorcycle Products

#SomosPartedeTuMoto

LESSIA  
Motorcycle Products



### MNG-001

MANGUERA DE GASOLINA (18 METROS)-  
(Xtreme)

MOTONETAS Y MOTOS DE TRABAJO



### MED-018

MEDIDOR DE ACEITE BAYONETA-(classic)

IT 125-FL 19-20 /IT 125-FL PARRILLA LARGA 19-20



### MED-SAE-01

MEDIDOR DE ACEITE BAYONETA-(classic)

IT 125-Z 16-17 /IT AR-110 15 /IT AT-110 14-16 /IT AT-110 NEGRA 16-17 /IT AT-110 RT 12-14 /IT AT-110RTLED 14-16



### MED-021

MEDIDOR DE ACEITE BAYONETA-(classic)

IT 150-SZ 16-18 /IT 150-Z 14-16 /IT 150-Z 19-20



### MED-022

MEDIDOR DE ACEITE BAYONETA-(classic)

IT 170-Z 16-18 /IT 200-Z 19-20



### MED-023

BAYONETA-(Classic)

IT ATV-200 20-24



### MED-019

MEDIDOR DE ACEITE BAYONETA-(classic)

IT ATV-250 C/REVERSA 14-18 /IT ATV-250 NE 18-20



### MED-013

MEDIDOR DE ACEITE BAYONETA-(classic)

IT ATV-250 C/REVERSA 14-18 /IT ATV-250 NE 18-20



Linea de Motor

MOTOR LINE

LESSIA  
Motorcycle Products

#SomosPartedeTuMoto

LESSIA  
Motorcycle Products



### MED-GY-01

#### MEDIDOR DE ACEITE BAYONETA-(classic)

IT CS-125 14-17 /IT CS-125  
LED 13-16 /IT D-125 16-17 /IT  
DS-125 17 /IT DS-150 14-17 /  
IT DS-150 NEGRO 13-15 /IT  
DSG 125 17-21



### MED-CGM-01

#### MEDIDOR DE ACEITE BAYONETA-(classic)

IT DM-150 10-17 /IT  
ARGENTA 110 05-07 /IT  
FORZA 125 05-12 /IT FORZA  
150 06-13 /IT EX 200 05-07 /  
IT FT-125 PLATA



### MED-020

#### MEDIDOR DE ACEITE BAYONETA-(classic)

VN TORNADO-250 05-08 /  
IT RC-150 09-17



### LEV-008

#### LEVA DE CLUTCH-(classic)

IT 125-FL 19-20 /IT 125-FL  
PARRILLA LARGA 19-20



### LEV-009

#### LEVA DE CLUTCH-(classic)

IT 125-Z 16-18 / IT 150-SZ  
16-18 /IT 150-Z 14-16 /IT 150-Z  
19-20/ DI US 150 MAX 2 175



### LEV-003

#### LEVA DE CLUTCH-(classic)

IT 250-Z 14-17 /IT 250-Z  
NEGRA 17-19 /IT DM-250 16-  
18 /IT RT-250 16-19



### LEV-001

#### LEVA DE CLUTCH-(classic)

IT AT-110 SPORT 11-15 /IT AR-  
110 15 /IT AT-110 14-16 /IT AT-  
110 /IT ARGENTA-110 06-13



### LEV-010

#### LEVA DE CLUTCH-(classic)

IT DM-125 17-20 /IT DM-150  
SPORT 19-20 /IT DM-250 20



Linea de Motor

MOTOR LINE

LESSIA  
Motorcycle Products

#SomosPartedeTuMoto

LESSIA<sup>®</sup>  
Motorcycle Products



### LEV-005

#### LEVA DE CLUTCH-(classic)

IT DT-125 CLASICA 17 /IT DT-125 DELIVERY 17 /IT DT-125 SPORT 17 /IT DT-150 SPORT 17 /IT FORZA 150 09-13



### LEV-007

#### LEVA DE CLUTCH-(classic)

IT DT-90 17 / IT ST-90 09-18



### LEV-006

#### LEVA DE CLUTCH-(classic)

IT FT-250 TS / IT FT-250 / IT FT-200 /IT FT-200 AMARILLA /IT 250-SZ /IT DT-200 SPORT /IT TC-200 / IT RC-200 /IT TC-250

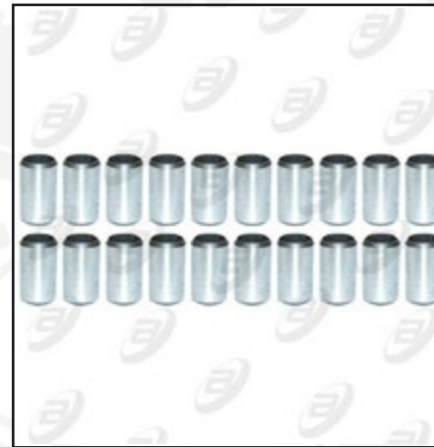

### PSG-001

#### PASADOR GUIA DE SUJECION 10 X 8-(classic)

IT ATV-150 05-11 /IT CS-125 14-18 /IT CS-125 LED 13-16 /IT D-125 16-18 /IT DS-150 14-18 / IT DS-150 NEGRO



### PIC-010

#### PISTON COMPLETO STD- (Rudos Biker)

BJ NS-200



### PIC-008

#### PISTON COMPLETO STD- (Rudos Biker)

HO CARGO-150 GL



### PIC-009

#### PISTON COMPLETO STD- (Rudos Biker)

HO CGL-125 TOOL



### PIC-IR22

#### PISTON COMPLETO STD- (Iron Box)

IT 125-FL 19-20 /IT 125-FL PARRILLA LARGA 19-20



Linea de Motor

MOTOR LINE

LESSIA  
Motorcycle Products

#SomosPartedeTuMoto

LESSIA  
Motorcycle Products



### PIC-IR15

PISTON COMPLETO STD-  
(Iron Box)

IT 125-Z 16-17



### PIC-F15

PISTON COMPLETO STD-  
(kiirus)

IT 125-Z 16-17



### PIC-IR06

PISTON COMPLETO STD-  
(Iron Box)

IT 150-SZ 16-18 /IT 150-Z  
14-16 /IT DM-150 10-18 /IT  
DM-150 ROJA 18 /IT DT-150  
CLASICA 17-18 /IT DT-150  
DELIVERY 17-18



### PIC-F06

PISTON COMPLETO  
KIIRUS STD-(kiirus)

IT 150-SZ 16-18 /IT 150-Z  
14-16 /IT DM-150 10-18 /IT  
DM-150 ROJA 18 /IT DT-150  
CLASICA 17-18 /IT DT-150  
DELIVERY 17-18



### PIC-F18

PISTON COMPLETO  
KIIRUS STD-(kiirus)

IT 170-Z 16-18



### PIC-F14

PISTON COMPLETO  
KIIRUS STD-(kiirus)

IT 250-SZ 15 / IT FIERA-250  
18 /IT FT-250 15-16 /IT FT-  
250-TS 16-18 /IT TC-250 15-18



### PIC-IR14

PISTON COMPLETO STD-  
(Iron Box)

IT 250-SZ 15 /IT FIERA-250  
18 /IT FT-250 15-16 /IT FT-  
250-TS 16-18 /IT TC-250 15-18



### PIC-F02

PISTON COMPLETO  
KIIRUS STD-(kiirus)

IT 250-Z 14-17 /IT 250-Z  
NEGRA 17 /IT DM-250 16 /IT  
RT-250 16-17





**PIC-IR02**

**PISTON COMPLETO STD-  
(Iron Box)**

IT 250-Z 14-17 /IT 250-Z  
NEGRA 17 /IT DM-250 16 /IT  
RT-250 16-17/TK TEKKEN R-  
250 19-21/MB HORNET-250  
20-21



**PIC-F10**

**PISTON COMPLETO STD-  
(kiirus)**

IT AT-110 14-21 /IT FT-110  
10-16



**PIC-IR10**

**PISTON COMPLETO STD-  
(Iron Box)**

IT AT-110 14-21 /IT FT-110  
10-16



**PIC-IR25**

**PISTON COMPLETO STD-  
(Iron Box)**

IT AT-125 17-20/IT AT-125RT  
20-21



**PIC-F09**

**PISTON COMPLETO  
KIIRUS STD-(kiirus)**

IT ATV-150 05 /IT DS-150  
06-18 /IT DS-150G 18 /IT  
DS-150 VERDE 18 /IT DS-150  
NEGRO 13-15 /IT GS- 150 10-  
13/VN ATOM-150 14-18



**PIC-IR09**

**PISTON COMPLETO STD-  
(Iron Box)**

IT ATV-150 05 /IT DS-150  
06-18 /IT DS-150G 18 /IT  
DS-150 VERDE 18 /IT DS-150  
NEGRO 13-15 /IT GS- 150 10-  
13 /VN TERRA-150 15-19/VC  
HAWK-150/VN ATOM-150  
14-18



**PIC-IR32**

**PISTON COMPLETO STD-  
(Iron Box)**

IT ATV-200 20-23



**PIC-IR08**

**PISTON COMPLETO STD-  
(Iron Box)**

IT CS-125 /IT DS-125



Linea de Motor

MOTOR LINE

LESSIA  
Motorcycle Products

#SomosPartedeTuMoto

LESSIA  
Motorcycle Products



### PIC-F08

PISTON COMPLETO  
KIIRUS STD-(kiirus)

IT CS-125 /IT DS-125



### PIC-IR19

PISTON COMPLETO STD-  
(Iron Box)

IT DM-125 17-19



### PIC-IR24

PISTON COMPLETO STD-  
(Iron Box)

IT DM-150 SPORT 19-20



### PIC-IR13

PISTON COMPLETO STD-  
(Iron Box)

IT DM-200 14-20/IT DM-200  
SP 19-20/IT DM-200 07-08/  
IT RC-200 09/IT TX-200 07-  
08



### PIC-F13

PISTON COMPLETO  
KIIRUS STD-(kiirus)

IT DM-200 14-20/IT DM-200  
SP 19-20/IT DM-200 07-08/  
IT RC-200 09/IT TX-200 07-  
08



### PIC-F03

PISTON COMPLETO STD-  
(kiirus)

IT DT-125 12-16 /IT DT-125  
CLASICA 17 /IT DT-125  
DELIVERY 17 /IT DT-125  
SPORT 17 /IT FORZA 125 05-  
12 /IT FT-125 CLASICA 12-16



### PIC-IR03

PISTON COMPLETO STD-  
(Iron Box)

IT DT-125 12-16 /IT DT-125  
CLASICA 17 /IT DT-125  
DELIVERY 17 /IT DT-125  
SPORT 17 /IT FORZA 125 05-  
12 /IT FT-125 CLASICA 12-16/  
VN SPECTRA-125 19-21



### PIC-IR20

PISTON COMPLETO STD-  
(Iron Box)

IT DT-200 SPORT 17-18 /  
IT FT-200 14-15 /IT FT-200  
AMARILLA 15-17 /IT TC-200  
14-16 /IT TC-200 BLANCA  
16-18



Linea de Motor

MOTOR LINE

LESSIA  
Motorcycle Products

#SomosPartedeTuMoto

LESSIA  
Motorcycle Products



### PIC-F05

#### PISTON COMPLETO KIIRUS STD-(kiirus)

IT EX-200/MOTOCARRO  
JINLUN-200 10-17



### PIC-F04

#### PISTON COMPLETO KIIRUS STD-(kiirus)

IT FT-150 STD/IT FT-180 13-  
20/IT FT-180 TS 19-21/IT RT-  
180 11-13/KU DELIVERY-125



### PIC-IR04

#### PISTON COMPLETO STD- (Iron Box)

IT FT-150 STD/IT FT-180 13-  
20/IT FT-180 TS 19-21/IT RT-  
180 11-13/KU DELIVERY-125/  
VN STREET ROD-150 19-21



### PIC-F07

#### PISTON COMPLETO KIIRUS STD-(kiirus)

IT GSC-175 15-17 /IT GTS-175  
10-14 /IT GTS-175 CON LEDS  
13-15 /IT GTS-175 LED CAJA  
14-15 /IT TRN-175 16



### PIC-IR07

#### PISTON COMPLETO STD- (Iron Box)

IT GSC-175 15-17 /IT GTS-175  
10-14 /IT GTS-175 CON LEDS  
13-15 /IT GTS-175 LED CAJA  
14-15 /IT TRN-175 16 /IT TS-  
170 09



### PIC-IR30

#### PISTON COMPLETO STD- (Iron Box)

VN NITROX-250T2 21-22/VN  
NITROX-250T3 22-24



### PIC-IR23

#### PISTON COMPLETO STD- (Iron Box)

IT RC-200 19-20 /IT  
SPITFIRE 19



### PIC-F11

#### PISTON COMPLETO KIIRUS STD-(kiirus)

IT ST-70



Linea de Motor

MOTOR LINE

LESSIA  
Motorcycle Products

#SomosPartedeTuMoto

LESSIA  
Motorcycle Products



### PIC-IR26

PISTON COMPLETO STD-  
(Iron Box)

IT V-200 18-20



### PIC-IR28

PISTON COMPLETO STD-  
(Iron Box)

IT VORTX-300 17-21/IT  
VORTX-300R 21



### PIC-IR27

PISTON COMPLETO STD-  
(Iron Box)

IT VX-250 21/IT VX-250AD  
16-18/IT VX-250EFI 18-21



### PIC-IR33

PISTON COMPLETO STD

SK GIXXER-150 21-23



### PIC-IR31

PISTON COMPLETO STD-  
(Iron Box)

VN CYCLONE-150 20-22/VN  
LITHIUM 4.0-150 20-22/VN  
RYDER 3.0-150 20-22/VN  
WORKMAN-150 20-22/VN  
XPRESS-150 16-22



### PIC-IR29

PISTON COMPLETO STD-  
(Iron Box)

VN ROCKETMAN-250  
19-22/VN ROCKETMAN-  
250SP 21-22/VN  
ROCKETMAN-250CR 21-22/  
VN CROSSMAX-250 19-22/  
VN CROSSMAX-250PRO  
21-22/VN SCREAMER-250  
22/VN FALKON-250 21-22/  
VN STORM-250 21-22/VN



### PIC-IR01

PISTON COMPLETO STD-  
(Iron Box)

YA YBR-125



### PIC-F01

PISTON COMPLETO  
KIIRUS STD-(kiirus)

YA YBR-125



Linea de Motor

MOTOR LINE

LESSIA  
Motorcycle Products

#SomosPartedeTuMoto

LESSIA  
Motorcycle Products



### BLA-003

BIELA COMPLETA-(classic)

HO CG-150



### BLA-001

BIELA COMPLETA-(classic)

IT FT-125 05-12 / IT 125-Z 19 /  
IT DT-125 CLASICA 17-19 /  
IT DT-125 DELIVERY / IT DT-  
125 SPORT 17-20 / IT FT-125  
CLASICA 12-16 / IT FT-125  
DELIVERY 14-16 / IT FT-125  
PLATA 17 / IT FT-125 ROJA  
13-18 / IT FT-125 ROJA 18-19 /  
IT FT-125 TS 16-19



### BLA-002

BIELA COMPLETA-(classic)

IT DM-150 10-19 / IT DT-150  
SPORT 17-18 / IT FORZA-150  
09-13 / IT FT-150 14-16 / IT FT-  
150 AZULP 13-16 / IT FT-150  
G 16-18 / IT FT-150 G NEGRA  
18-19 / IT FT-150 GT 11-13 / IT  
FT-150 GT GRAFITO 13-14 /  
IT FT-150 GTI 15-17 / IT FT-150  
GTS 18-19 / HO CARGO-125 /  
IT 125-Z 16-20 / IT 150-SZ 16-



### PLA-009

PLATOS OPRESORES-  
(Rudos Biker)

BJ BOXER-150



### PLA-010

PLATOS OPRESORES-  
(Rudos Biker)

BJ NS-200



### PLA-003

PLATOS OPRESORES-  
(classic)

HO TITAN-150



### PLA-016

PLATOS OPRESORES-  
(classic)

IT 125-FL 19-21 / IT 125-FL PAR  
19-20



### PLA-002

PLATOS OPRESORES-  
(classic)

IT 125-Z 16-17 / IT 150S-Z 16-  
17 / IT 150-Z 14-16 / IT 250S-Z  
15 / IT 250-Z 14-17 / IT 250-Z  
NEGRA 17 / IT DM-150 10-17



Linea de Motor

MOTOR LINE

LESSIA  
Motorcycle Products

#SomosPartedeTuMoto

LESSIA<sup>®</sup>  
Motorcycle Products



**PLA-012**

**PLATOS OPRESORES-  
(classic)**

IT 200-Z 19-22



**PLA-005**

**PLATOS OPRESORES-  
(classic)**

IT AT-110 NEGRA 16-17 /IT  
AX-110 16 / IT T-REX-70 14-  
15 /IT XT-110 11-15 /IT XT-110  
GRAFITO 13-17



**PLA-014**

**PLATOS OPRESORES-  
(classic)**

IT ATV-250REV 14-18/IT ATV-  
250NE 18-21/IT ATV-250CAM  
21



**PLA-011**

**PLATOS OPRESORES-  
(classic)**

IT DM-125 17-19



**PLA-007**

**PLATOS OPRESORES-  
(classic)**

IT FT-180 13-18 /IT RT-180  
11-13



**PLA-004**

**PLATOS OPRESORES-  
(classic)**

VN TORNADO-250 19-20/  
IT 250-SZ 15/ IT DT-200SP  
17/ IT FT-200 14-15/ IT FT-  
200AMA 15/ IT FT-250 15-16/  
IT FT-250TS 16-17



**PLA-018**

**PLATOS OPRESORES**

SK GIXXER-150



**PLA-001**

**PLATOS OPRESORES-  
(classic)**

YA YBR-125



Linea de Motor

MOTOR LINE

LESSIA  
Motorcycle Products

#SomosPartedeTuMoto

LESSIA  
Motorcycle Products



**RCA-005**  
REPUESTOS DE  
CARBURADOR-(classic)  
HO CARGO-125



**RCA-001**  
REPUESTOS DE  
CARBURADOR-(classic)  
IT 125-Z 16-17 /IT DT-125  
CLASICA 17 /IT DT-125  
DELIVERY 17 /IT DT-125  
SPORT 17 /IT FORZA 125 05-  
12 /IT FT-125 CLASICA 12-16



**RCA-007**  
REPUESTOS DE  
CARBURADOR-(classic)  
IT 250-SZ 15 /IT FT-250 15-16  
/IT FT-250 TS 16-17



**RCA-020**  
REPUESTOS DE  
CARBURADOR-(classic)  
IT 250-Z /IT 250-Z NE

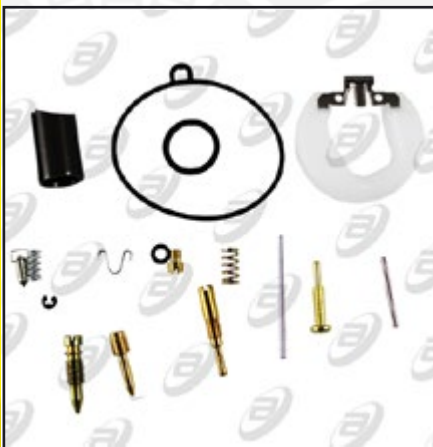

**RCA-017**  
REPUESTOS DE  
CARBURADOR-(classic)  
IT AT-125 /IT AT-110 /IT AT-110  
NE /IT AX-110 /IT XT-110 /IT  
XT-110 GR/DI MONKYE-125  
19-20



**RCA-013**  
REPUESTOS DE  
CARBURADOR-(classic)  
IT CS-125 14-18 /IT CS-125  
LED 13-16 /IT DS-125 05-18 /  
IT CITY-125 05-13 / IT X-125G  
19 /IT X-125GTS 19 / IT XS-125  
10-18



**RCA-008**  
REPUESTOS DE  
CARBURADOR-(classic)  
IT DM-150 10 -17 /IT RC-150  
GT 09-17/DI U5-150 15-20/DI  
MAX 2-175 15-20



**RCA-009**  
REPUESTOS DE  
CARBURADOR-(classic)  
IT DM-200 14-17/DI  
HEAVY-200 19-20





### RCA-003

#### REPUESTOS DE CARBURADOR-(classic)

IT DS-150 NEGRO 13-15 /IT DS-150 16-17 /IT GS-150 LED CAJA 14-15 /IT GS-150LED ELITE 15-17 /IT GSC-150 15-16 /DI ALIEN R-150 19-21/DI ADVENTURE-150 19-21



### RCA-002

#### REPUESTOS DE CARBURADOR-(classic)

IT FT-150GT / KUI DELIVERY MAX-150 11-12



### RCA-011

#### REPUESTOS DE CARBURADOR-(classic)

IT FT-180 13-17 /IT RT-180 11-13



### RCA-019

#### REPUESTOS DE CARBURADOR-(classic)

IT TC-200 14-16 /IT TC-200 BL 16-18 /IT TC-250 15-19



### RCA-015

#### REPUESTOS DE CARBURADOR-(classic)

IT W-150 17-19 /IT WS-150 08-19 /IT WS-150NF 13-14 /IT WS-150 SP 17-19 /IT XW-150 18-19



### RCA-014

#### REPUESTOS DE CARBURADOR-(classic)

IT WS-175 SP 18-19 /IT WS-175 12-18 /IT GSC-175 15-18 /IT TRN-175 16 /IT GTS-175 LED CAJA 14-15 /IT GTS-175 LEDS



### RCA-016

#### REPUESTOS DE CARBURADOR-(classic)

IT X-110 /IT XT-110RT II /IT AT-110 RO



### RCA-006

#### REPUESTOS DE CARBURADOR-(classic)

YA YBR-125



Linea de Motor

MOTOR LINE

LESSIA  
Motorcycle Products

#SomosPartedeTuMoto

LESSIA  
Motorcycle Products



### RCA-021

REPUESTOS DE  
CARBURADOR

YA FZ-16



### RET-015

RETEN DE ACEITE  
23\*37\*7-(classic)

IT 125-Z /IT 170-Z /IT AT-110  
NEGRA /IT AX-110 /IT DT-150  
SPORT /IT FORZA-150 /IT  
FT-150 /IT FT-150 AZULP /IT  
FT-150G

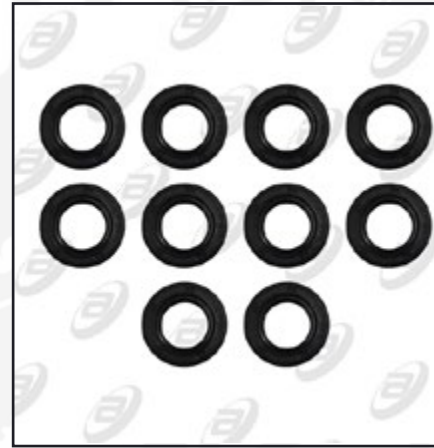

### RET-006

RETEN DE ACEITE  
17\*29\*5-(classic)

IT 125-FL 19-20 /IT 125-FL  
PAR LARGA 19-10 /IT AR-  
110 15 /IT AT-110 14-20 /IT  
AT-110NE 16-18 /IT AT-110RO  
17-19



### RET-011

RETEN DE ACEITE  
20\*34\*7-(classic)

IT 125-Z 16-18 /IT 150-SZ 16-18  
/IT 150-Z 14-16 /IT DM-150  
10-18 /IT DM-150 ROJA 18 /IT  
DT-125 12-16 /IT DT-125



### RET-020

RETEN DE ACEITE  
30\*42\*10.3-(classic)

IT CS-125 14-17 /IT CS-125  
LED 13-16 /IT D-125 16-17 /IT  
DS-125 17 /IT DS-150 14-17 /IT  
DS-150 NEGRO 13-15



### RET-009

RETEN DE ACEITE  
34\*50\*7-(classic)

IT FT-125 /IT FT-125 CLASSIC  
/ KU CLASSIC-125



### RET-010

RETEN DE ACEITE  
14\*28\*7-(classic)

IT FT-125 /IT FT-125 CLASSIC  
/ KU CLASSIC 125



### RET-013

RETEN DE ACEITE  
16\*28\*7-(classic)

IT FT-125 /IT FT-125 CLASSIC  
/ KU CLASSIC 125



Linea de Motor

MOTOR LINE

LESSIA  
Motorcycle Products

#SomosPartedeTuMoto

LESSIA  
Motorcycle Products



**RET-017**

RETEN DE ACEITE  
19.8\*30\*5-(classic)

MOTOR GY6-125 / 150 / 175



**RET-019**

RETEN DE ACEITE  
27\*42\*7-(classic)

MOTOR GY6-125 / 150 / 175



**RET-073**

RETENES DE MOTOR-  
(classic)

BJ BAJAJ-150



**RET-028**

RETEN DE MOTOR-  
(classic)

HO CARGO-125 06-10

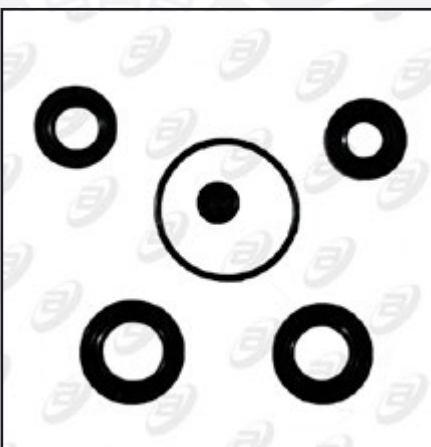

**RET-076**

RETENES DE MOTOR-  
(Rudos Biker)

HO CG-125

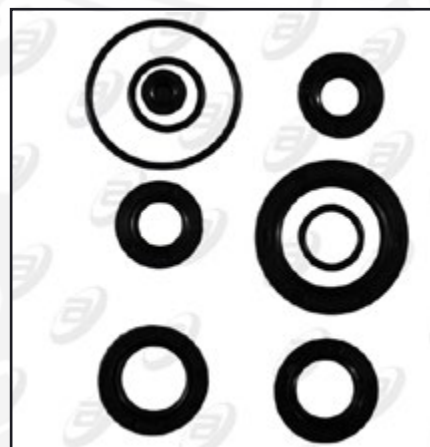

**RET-075**

RETENES DE MOTOR-  
(Rudos Biker)

HO CG-150



**RET-065**

RETENES DE MOTOR-  
(Rudos Biker)

HO CGL-125 TOOL



**RET-080**

RETENES DE MOTOR-  
(classic)

IT AR-110 /IT XT-110 /IT AT-125



Linea de Motor

MOTOR LINE

LESSIA  
Motorcycle Products

#SomosPartedeTuMoto

LESSIA<sup>®</sup>  
Motorcycle Products



### RET-081

RETENES DE MOTOR-  
(classic)

IT AT-110



### RET-SAE-01

RETEN DE MOTOR-  
(classic)

IT AT-110 NEGRA 16-17 /IT  
FT-110 10-16

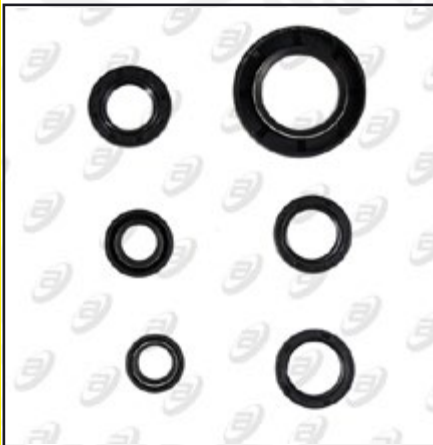

### RET-084

RETENES DE MOTOR-  
(classic)

IT ATV-150 SPORT C/  
REVERSA 12-19 / IT ATV-150  
C/ REVERSA 19-20 /IT ATV-  
180 16-20



### RET-085

RETENES DE MOTOR-  
(classic)

IT ATV-250



### RET-GY-04

RETEN DE MOTOR-  
(classic)

IT CS-125 / IT DS-125



### RET-087

RETENES DE MOTOR-  
(classic)

IT DM-125



### RET-GY-05

RETEN DE MOTOR-  
(classic)

IT DS-150 / IZUKA SL-125 /  
IZUKA SL-150 /IT WS-150 /IT  
GS-150



### RET-CGF-01

RETEN DE MOTOR-  
(classic)

IT FT-125 / KU CLASSIC-125  
08



Linea de Motor

MOTOR LINE

LESSIA  
Motorcycle Products

#SomosPartedeTuMoto

LESSIA  
Motorcycle Products



### RET-CGG-01

RETEN DE MOTOR-  
(classic)

IT FT-150 / KU DELIVERY  
MAX-150 08



### RET-077

RETENES DE MOTOR-  
(classic)

IT FT-180 13-20/IT FT-200 14-  
15 /IT TC-200 14-16/IT DM-  
150 10-23/IT 150-Z 14-22/IT  
150-SZ 16-18/IT 125-Z 16-22/IT  
DM-200 14-23/IT FIERA-150  
18-19



### RET-072

RETENES DE MOTOR-  
(Rudos Biker)

IT FZ-16

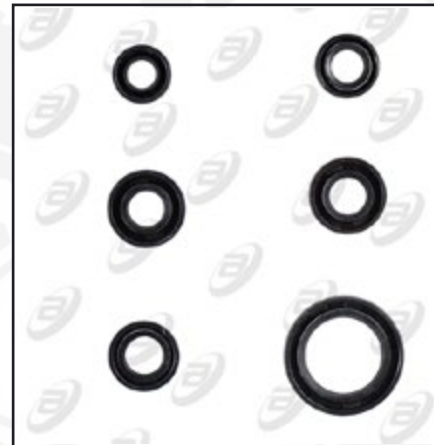

### RET-070

RETENES DE MOTOR-  
(Rudos Biker)

IT NS-200



### RET-086

RETENES DE MOTOR-  
(classic)

IT RT-200



### RET-082

RETENES DE MOTOR-  
(classic)

IT RT-250 /IT 170-Z /IT 250-Z



### RET-083

RETENES DE MOTOR-  
(classic)

IT TC-250



### RET-090

RETENES DE MOTOR-  
(classic)

IT V-200 18/IT VORTX-200  
18 /IT VX-250ADV 16-18/IT  
VX-250EFI 18/IT FORZA-150  
06-08/IT RT-200 09-13/IT  
RT-200NE 13-15/IT ATV-150



Linea de Motor

MOTOR LINE

LESSIA  
Motorcycle Products

#SomosPartedeTuMoto

LESSIA<sup>®</sup>  
Motorcycle Products

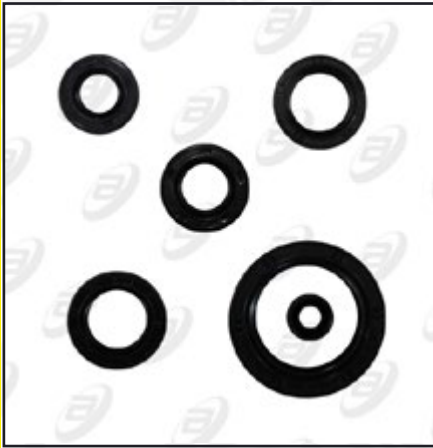

### RET-074

RETENES DE MOTOR-  
(classic)

GN-125



### RET-100

RETENES DE MOTOR

VC XEVERUS-250



### RET-030

RETEN DE MOTOR-  
(classic)

YA YBR-125 06-10



### REV-003

RETEN DE VALVULAS  
(ASIENTO)-(classic)

IT 125-Z 16-18 /IT 150-SZ 16-18  
/IT 150-Z 14-16 /IT DM-150  
10-18 /IT DT-125 12-16 /IT DT-  
125 CLASICA 17-18



### RET-SAE-02

RETEN DE VALVULA-  
(classic)

IT 170-Z / IT DM-250 16-17 /IT  
AT-110 /IT AR-110 /IT AT-110RT  
/IT AT-110 SPORT /IT AX-100  
16 /IT DT-90 / IT ST-70



### RET-CGM-01

RETEN DE VALVULA-  
(classic)

IT 250S-Z 15 /IT DT-200  
SPORT 17 /IT FT-180 13-17 /  
IT FT-200 14-15 /IT FT-200  
AMARILLA 15 /IT FT-250  
15-16

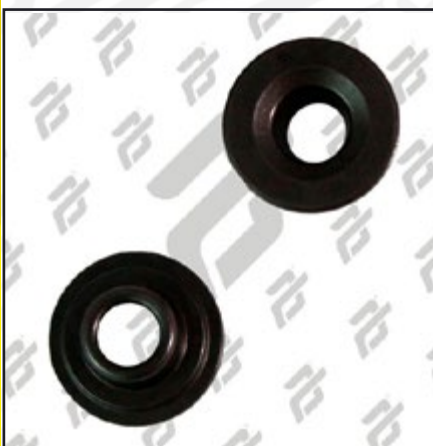

### REV-001

RETEN DE VALVULA-  
(classic)

IT CS-125 14-18 / IT CS-125  
LED 13-16 /IT D-125 16-18 /IT  
DS-125 17-18 / IT DS-150 14-  
18 /IT DS-150G 18 /IT DS-150  
VERDE 18-19



### RET-CGM-02

RETEN DE VALVULA-  
(classic)

IT DM-200 14-21 /IT DM-200  
SPORT 19-21 /IT DM-250  
20-21





**RET-GY-03**

**RETEN DE VALVULA-  
(classic)**

IT VS-90 / IT CS-125 / IT DS-125 / IT DS-150 / IT WS-150 / IT GS-150



**RET-089**

**RETEN DE BOMBA DE  
AGUA-(Rudos Biker)**

BJ NS-200



**SEG-018**

**SEGURO DE VALVULA-  
(classic)**

IT 125-Z 1617 / IT 150-SZ 1617 / IT 150-Z 1416 / IT DM-150 1017 / IT DT125 1216 / ITDT-125 CLASICA 17 / IT DT-125 DELIVER/UNIVERSAL



**SEG-019**

**SEGURO DE VALVULA-  
(classic)**

IT CS-125 1417 / IT CS-125 LED 1316 / IT D-125 1617 / IT DS125 17 / IT DS-150 1417 / IT DS-150 NEGRO 13-15



**SEN-007**

**SENSOR DE CAMBIOS  
12Vcc-(classic)**

IT 125-FL 19-22 / IT 125-FL PARRILLA 19-20



**SEN-001**

**SENSOR DE CAMBIOS  
12Vcc-(classic)**

IT 125-Z 16-17 / IT 150S-Z 16-17 / IT 150-Z 14-16 / IT 170-Z 16-17 / IT DT-125 CLASICA 17 / IT DT-125 DELIVERY 17



**SEN-010**

**SENSOR DE CAMBIOS  
12Vcc-(Gold)**

IT 250-Z 19-21 / IT DM-250 16-18 / IT RT-250 16-20



**SEN-009**

**SENSOR DE CAMBIOS  
12Vcc-(Gold)**

IT ATV-150REV 19-21 / IT ATV-150SP REV 12-19 / IT ATV-180 17-20 / IT ATV-200 20





**SEN-008**

**SENSOR DE CAMBIOS  
12Vcc-(Gold)**

IT DM-150 10-19/IT DT-150SP  
17-18/IT FORZA-150 06-13/IT  
FT-150 14-16/IT FT-150GTI 15-  
17/IT FT-150GTS RO 18-21



**SIN-003**

**SINCRONIZADOR DE  
CAMBIOS COMPLETO-  
(Rudos Biker)**

HO CGL-125 TOOL



**SIN-008**

**SINCRONIZADOR DE  
CAMBIOS (CLASSIC )**

IT 125-FL GPS 22-24/IT 125-  
FL 19-23/IT 125FL PAR LAR  
19-20



**SIN-006**

**SINCRONIZADOR DE  
CAMBIOS COMPLETO-  
(classic)**

IT 125-Z 16-18 /IT 150-SZ 16-18  
/IT 150-Z 14-16 /IT 170-Z 16-  
18 /IT 250-Z 14-17 /IT 250-Z  
NEGRA 17-19 /IT DM-150  
10-19



**SIN-002**

**SINCRONIZADOR DE  
CAMBIOS COMPLETO-  
(Gold)**

IT 250-SZ 15 /IT DT-200  
SPORT 17-18 /IT FIERA-200  
18 /IT FIERA-250 18 /IT FT-  
180 13-18 /IT FT-200 14-15



**SIN-012**

**SINCRONIZADOR DE  
CAMBIOS**

IT 250-Z 19-24/ IT DM-250  
16-18/ IT RT-250 16-20/ IT  
SPTFIRE-250 23-24/IT RT-  
250SP 20-24/IT RC-250 24



**SIN-011**

**SINCRONIZADOR DE  
CAMBIOS**

IT ATV-180 16-24/ IT ATV-  
150SP C/REV 12-19/ IT ATV-  
150 C/REV 19-24/ IT ATV-200  
20-24



**SIN-SAE-01**

**SINCRONIZADOR DE  
CAMBIOS COMPLETO-  
(Gold)**

IT AT-110 / KU GALAXY-150  
05-13





**SIN-001**

**SINCRONIZADOR DE CAMBIOS-(Gold)**

IT AT-110 NEGRA 16-18 /IT AX-110 16 /IT DT-90 17 /IT STRADA-70 05-08 /IT ST-90 09-18 /IT XT-110 11-15



**SIN-007**

**SINCRONIZADOR DE CAMBIOS COMPLETO-(classic)**

IT DM-150 10-19 /IT DT-150 SPORT 7-18 /IT FORZA-150 06-13 /IT FT-150 14-16 /IT FT-150 AZ 13-16 /IT FT-150G 16-18



**SIN-004**

**SINCRONIZADOR DE CAMBIOS COMPLETO-(classic)**

IT DM-200 14-19 /IT DM-125 17-18 /VN CROSS MAX-200 19-21



**SIN-005**

**SINCRONIZADOR DE CAMBIOS-(classic)**

IT DT-110 DELIVERY 16-18 /IT FT-115 16-18



**SIN-009**

**SINCRONIZADOR DE CAMBIOS ( CLASSIC )**

IT VORT-X250 22-24 /IT BLACKBIRD 21-24



**SIN-010**

**SINCRONIZADOR DE CAMBIOS ( CLASSIC )**

IT VORT-X300 17-24 /IT VORT-X300R 21-24

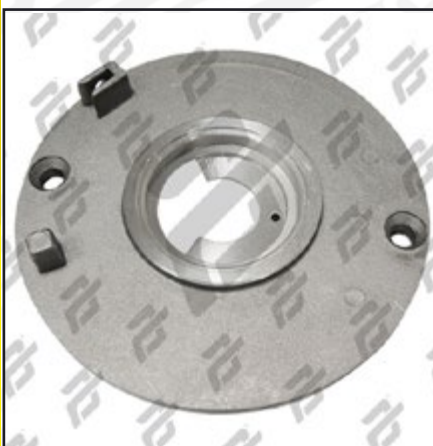

**BOM-A001**

**TAPA DE BOMBA DE ACEITE GRIS-(classic)**

IT AR-110 15 /IT AT-110 14-16 /IT AT-110 NEGRA 16-18 /IT AT-110 ROJA 17-18 /IT AT-110 RT 12-14 /IT AT-110 14-16



**TPN-007**

**TAPON DE DRENADO-(Rudos Biker)**

BJ NS-200 /BJ AS-200 /BJ RS-200





**TPN-005**

TAPON DE DRENADO C/  
ORING-(Rudos Biker)

HO CGL-125 TOOL



**TPN-006**

TAPON DE DRENADO-  
(classic)

IT 250-SZ 15 /IT DT-200  
SPORT 17-18 /IT FT-180 13-18  
/IT FT-200 14-15 /IT FT-200  
AMARILLA 15-17 /IT FT-250  
15-16



**TPN-004**

TAPON DEL AJUSTE DE  
VALVULAS-(classic)

IT AT-110 SPORT/IT AT-110 /  
GT-110 ALESSIA 14-16



**TPN-002**

TAPON DE DRENADO C/  
ORING-(classic)

IT CS-125 14-18 /IT CS-125  
LED 13-16 /IT D-125 16-18 /IT  
DS-125 17-18 /IT DS-150 14-  
18 /IT DS-150G 18 /IT DS-150  
VERDE 18-19



**TPN-CGM-01**

TAPON DE DRENADO C/  
ORING-(classic)

IT DT-150 SPORT /IT  
FORZA-150/ IT FT-150/ IT  
FT-150AZULP /IT FT-150G/  
IT FT-150GT/ IT FT-150GT  
GRAFITO/IT FT-150GTI



**VAL-017**

VALVULAS ADMISION Y  
ESCAPE-(classic)

IT 170-Z 16-17/IT DM-250 16-  
17/IT RT-250 16-18



**VAL-023**

VALVULAS CALIDAD  
GOLD (IRON BOX)  
(ADMISION Y ESCAPE)-  
(Iron Box)

IT AT-125 17-18



**VAL-027**

VALVULAS CALIDAD  
GOLD (IRON BOX)  
(ADMISION Y ESCAPE)-  
(Iron Box)

IT ATV-180 16-20



Linea de Motor

MOTOR LINE

LESSIA  
Motorcycle Products

#SomosPartedeTuMoto

LESSIA  
Motorcycle Products



### VAL-032

VALVULAS CALIDAD  
GOLD (IRON BOX)  
(ADMISION Y ESCAPE)-  
(Iron Box)

IT ATV-200 20-23



### VAL-025

VALVULAS CALIDAD  
GOLD (IRON BOX)  
(ADMISION Y ESCAPE)-  
(Iron Box)

IT ATV-250 C/REVERSA 14-  
18 /IT ATV-250 NEGRA 18-20



### VAL-GYF-01

VALVULAS ADMISION Y  
ESCAPE-(classic)

IT CS-125 / IT DS-125 08



### VAL-GYF-01F

VALVULAS ADMISION Y  
ESCAPE

IT CS-125 / IT DS-125 08



### VAL-CGG-01F

VALVULAS ADMISION Y  
ESCAPE

IT DM-150 10-18 / DM-150  
ROJA 18 / DT-150 BASIC 18  
/ DT-150 SPORT 17-18 / DT-  
150 SPORT II 17 / FO



### VAL-CGG-01

VALVULAS ADMISION Y  
ESCAPE-(classic)

IT DM-150 10-18 /IT DM-150  
ROJA 18 /IT DT-150 BASIC 18  
/IT DT-150 SPORT 17-18 /IT  
DT-150 SPORT II 17



### VAL-031

VALVULAS CALIDAD  
GOLD (IRON BOX)  
(ADMISION Y ESCAPE)-  
(classic)

IT DM-250X 22-24/IT  
TITAN-200 22/IT DM-250  
20-24



### VAL-GYG-01F

VALVULAS ADMISION Y  
ESCAPE

IT DS-150 / IZUKA SL-125 /  
IZUKA SL-150 / GS-150 / WS-  
150 / XS-150 / GTS-175 08-13 /  
TS-175 08-13





**VAL-GYG-01**

VALVULAS ADMISION Y ESCAPE-(classic)

IT DS-150 / IZUKA SL-125 / IZUKA SL-150 / IT GS-150 / IT WS-150 / IT XS-150 / IT GTS-175 08-13 / IT TS-175 08-13



**VAL-CGF-01**

VALVULAS ADMISION Y ESCAPE-(classic)

IT FT-125 / KU CLASSIC-125 2008



**VAL-CGF-01F**

VALVULAS ADMISION Y ESCAPE

IT FT-125 / KURAZAI CLASSIC 125 2008



**VAL-029**

VALVULAS ADMISION Y ESCAPE-(classic)

IT V-200 18-20



**VAL-030**

VALVULAS CALIDAD GOLD (IRON BOX) (ADMISION Y ESCAPE)- (Iron Box)

IT VORTX-200 18-21



**VAL-033**

VALVULAS CALIDAD GOLD (IRON BOX) (ADMISION Y ESCAPE)- (Iron Box)

IT VORTX-300 17-23/IT VORTX-300R 21-23



**VAL-022**

VALVULAS ADMISION Y ESCAPE-(Rudos Biker)

SK EN-125



**VAL-028**

VALVULAS CALIDAD (ADMISION Y ESCAPE)- (Iron Box)

IT 125 FL 19-20/IT 125 FL PARRILLA LARGA 19-20/HO DIO-110



Linea de Motor

MOTOR LINE

LESSIA  
Motorcycle Products

#SomosPartedeTuMoto

LESSIA  
Motorcycle Products



### VAL-013

VALVULAS CALIDAD  
(ADMISION Y ESCAPE)-  
(Iron Box)

IT 125-Z 16-17 /IT DT-125 12-  
16 /IT DT-125 CLASICA 17 /  
IT DT-125 DELIVERY 17 /IT  
DT-125 SPORT 17 /IT FORZA  
125 0



### VAL-012

VALVULAS CALIDAD  
(ADMISION Y ESCAPE)-  
(Iron Box)

IT 250-SZ 15/IT DT-250SP  
20/IT FIERA-250 18-19/IT FT-  
250 15-16/IT FT-250TS 16-24/  
IT TC-250 15-24/IT 250-Z  
14-17/IT 250-ZNE 17-19



### VAL-012F

VALVULAS CALIDAD  
(ADMISION Y ESCAPE)  
KIIRUS

IT 250-SZ 15/IT DT-250SP  
20/IT FIERA-250 18-19/IT FT-  
250 15-16/IT FT-250TS16-20/  
IT TC-250 15-20/IT 250-Z  
14-17/IT 250-ZNE 17-19



### VAL-SAE-02F

VALVULAS CALIDAD  
(ADMISION Y ESCAPE)  
KIIRUS

IT AR-110 15/IT AT-110 14-20/  
IT AT-110NE 16-18/IT AT-  
110RO 17-19/IT AT-110RT  
12-14/IT AT-110RTLED 14-16/  
IT AT-110RT C/LED 16-20/  
IT AT-110SP 11-15/IT AX-110  
16/IT DT-110DE 16-20/IT  
ARGENTA-110 05-13



### VAL-SAE-02

VALVULAS CALIDAD  
(ADMISION Y ESCAPE)-  
(Iron Box)

IT AR-110 15/IT AT-110 14-20/  
IT AT-110NE 16-18/IT AT-  
110RO 17-19/IT AT-110RT  
12-14/IT AT-110RTLED 14-16/  
IT AT-110RT C/LED 16-20/  
IT AT-110SP 11-15/IT AX-110  
16/IT DT-110DE 16-20/IT  
ARGENTA-110 05-13/IT ST-



### VAL-GYG-02

VALVULAS CALIDAD  
(ADMISION Y ESCAPE)-  
(Iron Box)

IT BIT-150 22/IT D-150 19-22/  
IT DS-150 14-22/IT DS-150G  
18-22/IT DS-150 VE 18-19/IT  
DS-150 NE 13-15/IT DS-150  
05-16/IT GS-150 10-13/IT GS-  
150 C/LED 13-15/IT GS-150  
LED ELITE 15-18/IT GSC-150  
15-16/IT GSC-175 15-18/IT



### VAL-GYF-02

VALVULAS CALIDAD  
(ADMISION Y ESCAPE)-  
(Iron Box)

IT CS-125 14-17 /IT CS-125  
LED 13-16 /IT D-12516-17 /IT  
DS-125 17 /IT DSG-125 17 /IT  
CITY-125 05-13 /IT DIABOLO  
12



### VAL-011

VALVULAS CALIDAD  
(ADMISION Y ESCAPE)-  
(Iron Box)

IT DT-200SP 17-20/IT  
FIERA-200 18-19/IT FT-200  
14-15/IT FT-200AM 15-17/IT  
FT-200TS 19-20/IT TC-200  
14-16/IT TC-200BL 16-18/IT  
TC-200NE 18-19/IT DM-200  
14-20/IT DM-200SP 19-20



Linea de Motor

MOTOR LINE

LESSIA  
Motorcycle Products

#SomosPartedeTuMoto

LESSIA  
Motorcycle Products



### VAL-01F

VALVULAS CALIDAD  
(ADMISION Y ESCAPE)  
KIIRUS

IT DT-200SP 17-20/IT  
FIERA-200 18-19/IT FT-200  
14-15/IT FT-200AM 15-17/IT  
FT-200TS 19-20/IT TC-200  
14-16/IT TC-200BL 16-18/IT  
TC-200NE 18-19/IT DM-200  
14-20/IT DM-200SP 19-20



### VAL-031F

VALVULAS CALIDAD  
(ADMISION Y ESCAPE)  
KIIRUS

IT DM-250X 22-24/IT  
TITAN-200 22/IT DM-250  
20-24



### VAL-009

VALVULAS CALIDAD  
(ADMISION Y ESCAPE)-  
(Iron Box)

IT EX-200 05-08



### VAL-CGG-02

VALVULAS CALIDAD  
(ADMISION Y ESCAPE)-  
(Iron Box)

IT FORZA-150 06-13/IT FT-  
150 14-16/IT 150-Z 14-20/IT  
150-SZ 16-18/IT FT-180 13-18/  
IT FT-180TS 19/IT RT-180 11-  
13/IT DM-150



### VAL-007

VALVULAS CALIDAD  
(ADMISION Y ESCAPE)-  
(Iron Box)

YA FZ-16 12-13



### VAL-010

VALVULAS CALIDAD  
(ADMISION Y ESCAPE)-  
(Iron Box)

YA YBR-125



### VAL-035

VALVULAS CALIDAD  
GOLD (IRON BOX)  
(ADMISION Y ESCAPE)

BJ PULSAR NS-150/  
BJ PULSAR AS-150/ BJ  
PULSAR NS-160



### VAL-021

VALVULAS ADMISION Y  
ESCAPE-(Rudos Biker)

BJ BOXER-150



Linea de Motor

MOTOR LINE

LESSIA  
Motorcycle Products

#SomosPartedeTuMoto

LESSIA  
Motorcycle Products



### VAL-015

VALVULAS ADMISION Y ESCAPE-(Rudos Biker)

BJ NS-200



### VAL-014

VALVULAS ADMISION Y ESCAPE-(Rudos Biker)

HO CARGO-150



### GVL-002

GUIA DE VALVULA ADMISION / ESCAPE-(classic)

IT D-150 19-20/IT ATV-150 05-19/IT ATV-180 16-20/IT DS-150 14-21/IT DS-150G 18-21/IT DS-150VE 18-19/IT DS-150NE 13-15



### GVL-001

GUIA DE VALVULA ADMISION / ESCAPE-(classic)

IT FT-125 /IT FT-150 / HO CARGO-125 /HO CARGO-150 / MOTOS DE TRABAJO 125cc / 150cc



### GVL-003

GUIA DE VALVULA ADMISION / ESCAPE-(classic)

YA YBR-125/YA FZ-16/IT 170-Z 16-18/IT 250-Z 19-21/IT DM-250 16-18/IT RT-250 16-20



### VAR-001

VARILLA DE EMPUJE DE BALANCIN-(Rudos Biker)

IT CGL-125 TOOL



### VAR-002

VARILLA DE EMPUJE DE BALANCIN-(classic)

IT DM-125 17-18



### VAR-CGM-01

VARILLA DE EMPUJE DE BALANCIN-(classic)

IT DT-125 12-16 /IT DT-125 CLASICA 17 /IT DT-125 DELIVERY 17 /IT DT-125 SPORT 17/IT DT-150 SPORT 17 /IT FORZA 12



Linea de Motor

MOTOR LINE

LESSIA  
Motorcycle Products

#SomosPartedeTuMoto

LESSIA  
Motorcycle Products



#### VAR-004

VARILLA DE EMPUJE DE  
BALANCIN-(classic)

IT EX-200 07-08 /IT RT-  
200GP 09-16 /IT RT-200  
NEGRO 13-15



#### VAR-CGM-02

VARILLA DE EMPUJE DE  
BALANCIN-(classic)

IT FT-180 13-17 /IT RT-180  
11-13



#### VAR-003

VARILLA DE EMPUJE DE  
BALANCIN-(classic)

IT FT-180 13-18 /IT RT-180  
11-13



#### VAR-005

VARILLA DE EMPUJE DE  
BALANCIN-(classic)

IT SPTFIRE-250 23